

User Manual

PV Combiner Box

PVS-16MH/PVS-18MH/PVS-20MH/PVS-24MH/PVS-16MH-EH/PVS-18MH-EH/PVS-20MH-EH/PVS-24MH-EH



All Rights Reserved

All Rights Reserved

No part of this document can be reproduced in any form or by any means without the prior written permission of Sungrow Power Supply Co., Ltd (hereinafter "SUNGROW").

Trademarks

SUNGROW and other SUNGROW trademarks used in this manual are owned by SUNGROW.

All other trademarks or registered trademarks mentioned in this manual are owned by their respective owners.

Software Licenses

- It is prohibited to use data contained in firmware or software developed by SUNGROW, in part or in full, for commercial purposes by any means.
- It is prohibited to perform reverse engineering, cracking, or any other operations that compromise the original program design of the software developed by SUNGROW.

Contents

All Rights Reserved.....	I
1 About This Manual.....	1
1.1 Validity.....	1
1.2 Target Group.....	1
1.3 How to Use This Manual.....	2
1.4 Symbol Explanations.....	2
1.5 Model Description.....	3
1.6 Related Documents.....	3
2 Safety Instructions.....	4
3 Product Description.....	7
3.1 Product Introduction.....	7
3.1.1 Overview.....	7
3.1.2 Main Features.....	7
3.1.3 Application Scenarios.....	7
3.2 External Structure.....	8
3.2.1 Appearance.....	8
3.2.2 External Dimensions.....	10
3.3 Internal Structure.....	10
4 Delivery and Storage.....	14
4.1 Scope of Delivery.....	14
4.2 Checking for Transport Damages.....	15
4.3 Storage.....	16
5 Transport and Installation.....	17
5.1 Transport.....	17
5.2 Installation Environment Selection.....	17
5.3 Preparation Before Installation.....	19
5.4 Installing PVS.....	20
5.4.1 Installing Hangers.....	20
5.4.2 Vertical Installation.....	21
5.4.2.1 Single-post Mounting Structure.....	21
5.4.2.2 Dual-post Mounting Structure.....	22
5.4.2.3 Subsequent Processing (Optional).....	24
5.4.3 Horizontal Installation.....	24
5.4.3.1 Installation Requirements.....	24

5.4.3.2 Positioning Hole.....	24
5.4.3.3 Procedure.....	25
5.4.3.4 Cable Securing and Protection.....	25
6 Electrical Connection.....	27
6.1 Safety Instructions.....	27
6.2 Wiring diagram.....	27
6.3 Preparation before Electrical Connections.....	28
6.3.1 Opening Cabinet Door.....	28
6.3.2 Power-off Preparation.....	29
6.3.3 Cable Requirements.....	29
6.3.4 Cable Layout.....	30
6.3.5 Waterproof Connector and Cable Specification.....	34
6.4 Input Connections.....	35
6.4.1 Safety Precautions.....	35
6.4.2 Special Connector for PV Cable.....	35
6.5 Output Connections.....	37
6.6 Ground Connection.....	39
6.7 Communication Connection.....	41
6.7.1 Communication Solution.....	41
6.7.2 RS485 Communication Wiring.....	42
6.8 Subsequent Processing.....	43
7 Commissioning.....	46
8 PVS Function Settings.....	47
8.1 Device Introduction.....	47
8.1.1 WEB.....	47
8.1.1.1 Preparation Before Login.....	47
8.1.1.2 Login Steps.....	47
8.1.2 iConfig.....	47
8.1.2.1 Preparation Before Login.....	47
8.1.2.2 Login Steps.....	49
8.2 PVS Communication Settings.....	50
8.2.1 Quick Networking.....	50
8.2.1.1 RS485 Auto Search.....	50
8.2.1.2 Change PVS Address.....	53
8.2.2 iConfig Local Access Address Settings.....	54
8.3 One-Click Trip.....	55
8.3.1 WEB One-Click Trip.....	55
8.3.2 iConfig One-Click Trip.....	57
8.3.3 One-Click Trip via Plant Backend.....	58

8.4 Other Functions.....	58
8.4.1 String Access Settings.....	58
8.4.2 Viewing Real-Time Information.....	59
9 Routine Maintenance.....	61
9.1 Brief Introduction.....	61
9.2 Maintenance Work.....	61
9.3 Fuse Replacement.....	62
9.4 Sealing Strip Replacement.....	63
10 Troubleshooting.....	64
10.1 Before Troubleshooting.....	64
10.2 Troubleshooting.....	64
11 Appendix.....	67
11.1 Technical Data.....	67
11.2 Quality Assurance.....	70
11.3 Contact Information.....	71

1 About This Manual

1.1 Validity

This manual is valid for the following PV combiner boxes:

- PVS-16MH
- PVS-18MH
- PVS-20MH
- PVS-24MH
- PVS-16MH-EH
- PVS-18MH-EH
- PVS-20MH-EH
- PVS-24MH-EH

Unless otherwise specified, any of the above products is hereinafter referred to as "PVS".

The above models are the same as PVS-24MH[-EH] in electrical structure, installation method, and usage. But the number of PV inputs connected to each model varies.

1.2 Target Group

This manual is for technical personnel who are responsible for the transport, installation, and operations of this product. Readers shall meet at least the following requirements:

- Know electronic, electrical wiring and mechanical expertise, and be familiar with electrical and mechanical schematics.
- Be familiar with the composition and working principles of grid-connected PV power generation system and the front- and rear-level equipment of the PVS.
- Have received professional training related to the installation and commissioning of electrical equipment.
- Be familiar with the relevant standards and specifications of the country/region where the project is located.
- Be familiar with the content of this manual.

Only personnel meeting the above requirements may perform installation, operation and maintenance, overhaul, and other operations on the PVS. Unauthorized personnel must not perform any operations on the PVS to avoid accidents.

1.3 How to Use This Manual

Read this manual carefully before transporting and installing the product. Please keep this manual and other materials of components together, and ensure that relevant personnel can easily access and use them.

All contents, pictures, marks, and symbols in the manual are owned by SUNGROW. No part of this document may be reprinted by the non-internal staff of SUNGROW without written authorization.

In order to continuously improve customer satisfaction, products, and product manuals of SUNGROW are always in the process of improvement and upgrade. If your manual is not in accord with the product, it may be due to the product version upgrade, and the actual product shall prevail. For any questions, please contact Sungrow Customer Service.

1.4 Symbol Explanations

This manual contains important instructions, which are highlighted with relevant symbols, to ensure personal and property safety during usage, or to help optimize the product performance in an efficient way.

Symbols that may be used in this manual are listed below. Please read them carefully to make better use of this manual.

DANGER

indicates a hazardous situation which, if not avoided, will result in death or serious injury.

WARNING

indicates a hazardous situation which, if not avoided, can result in death or serious injury.

CAUTION



indicates a slightly hazardous situation which, if not avoided, may result in minor or moderate injury.

NOTICE

indicates potential risks that, if not avoided, can lead to device malfunctions or financial losses.

Indicates additional information in this manual. This information emphasizes or supplements the content and may provide tips to better use the product, helping you solve problems or save time.

Always note hazard warnings on the device enclosure.

Marks	Explanation
	High voltage inside! Risk of electric shock by touching it!
	Temperature beyond the acceptable range for the human body. Do not touch it arbitrarily to avoid personal injury.
	Protective ground terminal which needs to be firmly grounded to ensure the safety of operators.

1.5 Model Description

Description of the PVS model is as follows:

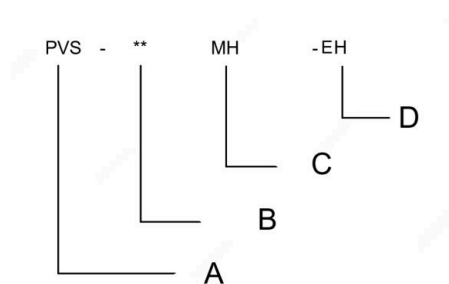

Each letter means:

- A: Code of the PVS
- B: Max. number of PV strings in parallel
- C: High voltage 1500V, with monitoring function
- D: External handle

1.6 Related Documents

With the inverter SCU, the functions of the PVS can be configured. For more detailed information, please refer to SCU1100 User Manual.

Manual	Source
SCU1100 User Manual	https://support.sungrowpower.com/Document

2 Safety Instructions

Please read this chapter carefully when installing and using the PVS. SUNGROW reserves the right not to assume responsibility and quality assurance for any personal injury or device damage due to failure to observe these safety precautions.

DANGER

There is a high voltage in the PV string. Accidental contact may cause fatal electric shock or severe burns. When wiring the PVS, observe the following safety precautions:

- Before wiring, please disconnect the end of PV strings.
- Before wiring, do not use an ordinary multimeter to measure the DC voltage. A multimeter with a withstand voltage of at least 1500 V is recommended. Otherwise, serious damage may follow.
- Please follow all safety instructions of the PV module manufacturer.

DANGER

Damaged equipment or system failure may cause electric shock or fire!

- Before operation, visually check the equipment for damage or other dangerous conditions.
- Check whether other external devices or circuit connections are in a safe state. Make sure the device is in a safe state before operating.

DANGER

Touching the internal terminals of the equipment may result in electric shock or fire!

- Do not touch the terminals or conductors connected to the inverter or string.
- Pay attention to all instructions or safety documents regarding the connection of PVS.

DANGER

High voltage inside! Risk of electric shock!

- Note and observe the warnings on the product.
- Respect all safety precautions listed in this manual and other pertinent documents.

⚠ DANGER

The grounding cable must be well connected to ground, otherwise:

- It may cause fatal electric shock to the operator in case of failure!
- The equipment may be damaged when struck by lightning!

⚠ WARNING

Incorrect cable connection can cause damage to PV modules, the PVS, and inverters. When wiring, observe the following precautions:

- Wire according to the wiring drawing.
- Measure the open circuit voltage of strings before wiring to ensure that the DC input voltage range meets the requirements of the PVS.
- Distinguish the positive and negative polarity of strings before wiring, and ensure that there is no ground fault.

⚠ WARNING

- Only professional electricians or qualified personnel can operate and wire the product.
- Operations and wiring must be done in accordance with relevant national and local standards.
- Warning signs must be legible and should be replaced immediately if damaged.

⚠ WARNING

Make sure that the fastening screws on terminals of the PVS are fastened in place. If the copper core of the cable cannot be fully contacted with the wiring terminal and pressed tightly, the terminal will be heated and burned after a prolonged period. Use stranded copper core flame-retardant cables with the wire diameter not less than the recommended value in the appendix. Fasten the screw cap of the waterproof terminal in place, otherwise, it may cause water leakage and damage to the PVS.

⚠ WARNING

Disconnect loads before checking and replacing fuses! Install or take out fuses when there is no load connected to avoid arc damage to the equipment and personal injury.

NOTICE

Be sure to lock the door after operation.
Do not open the door cover of the PVS frequently to avoid affecting its waterproof performance.

⚠ CAUTION

Touching the PCB or other static sensitive components may cause damage to components.

- Do not touch other parts inside the cabinet except the terminals during installation.
- Observe the regulations to protect against electrostatic and wear an anti-static wrist strap.

3 Product Description

3.1 Product Introduction

3.1.1 Overview

For large-scale grid-connected PV power generation systems, it is generally necessary to add a DC combiner device between PV modules and inverters to minimize cable connections, facilitate maintenance, and improve reliability.

The PVS independently developed and produced by SUNGROW is an outdoor combiner box. It is designed for meeting these requirements and provides a Turnkey solution for PV systems together with SUNGROW's PV inverters.

3.1.2 Main Features

- Meets outdoor installation requirements;
- Can be connected with multiple PV inputs, each is equipped with a fuse (can be replaced with a fuse of other degrees);
- Equipped with special PV high-voltage SPD, lightening protection for positive and negative polarities;
- Contains a current detector for monitoring the current of each string, uploaded through RS485 or DC MPLC communication;
- Monitor the bus voltage and upload it through RS485 or DC MPLC communication;
- Supports one-click establishment of DC MPLC communication among PVS devices when used with the SCU;
- Supports automatic search and address assignment for PVS devices via RS485 when used with the SCU.

3.1.3 Application Scenarios

The PVS in line with outdoor standards developed and produced by SUNGROW is mainly used in large and medium-sized PV plants. It adopts a modular design to achieve fast installation and to ensure a long-term, reliable, and safe grid-connected operation of the PV plant.

A PV power generation system with the PVS is shown in below.

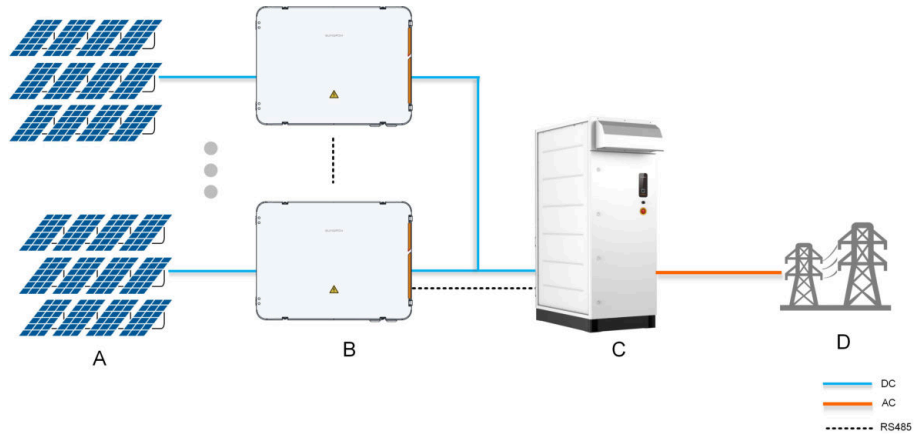

Figure 3-1 Composition of grid-connected PV generation system

Table 3-1 Device description

No.	Device
A	PV array
B	PVS
C	Inverter
D	Public power grid

3.2 External Structure

3.2.1 Appearance

Taking PVS-24MH[-EH] as an example, the appearance of the PVS is shown in the figure below.

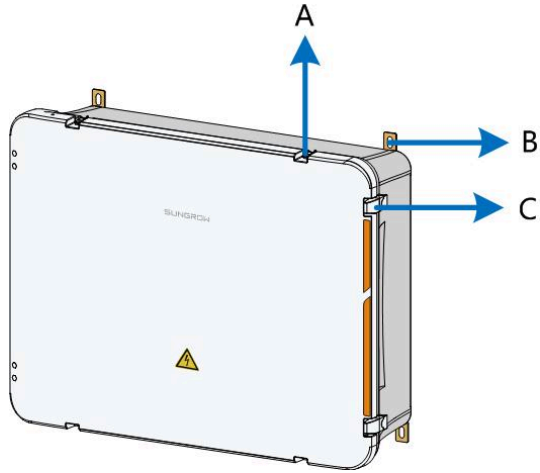

Figure 3-2 PVS-24MH

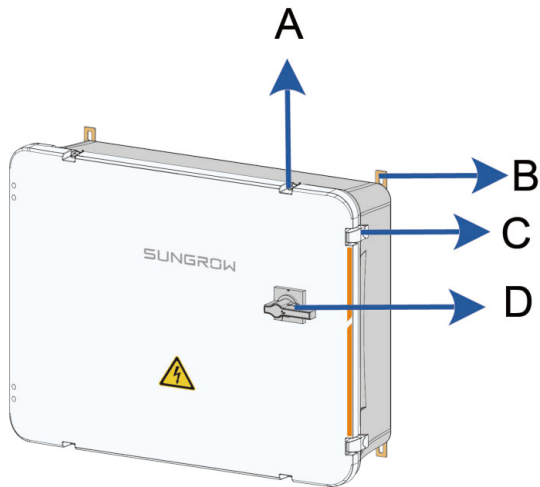

Figure 3-3 PVS-24MH-EH

*For subsequent demonstrations, only PVS-24MH will be used as an example.

No.	Name	Description
A	Clasp	-
B	Mounting hanger	Used to fix the PVS
C	Door lock	-
D	External handle	Power off

3.2.2 External Dimensions

Taking PVS-24MH as an example, the dimensions of the PVS is shown in the figure below.

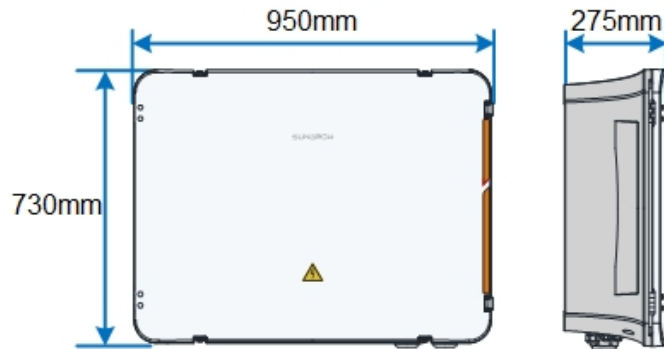

Figure 3-4 Dimensions

3.3 Internal Structure

Taking PVS-24MH as an example, the internal structure of the PVS is shown in the figures below.

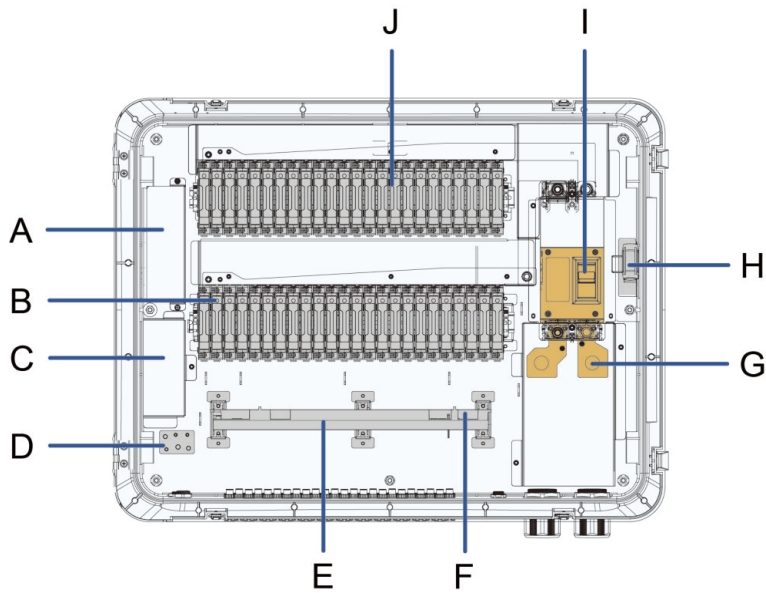

Figure 3-5 Negative fuse version

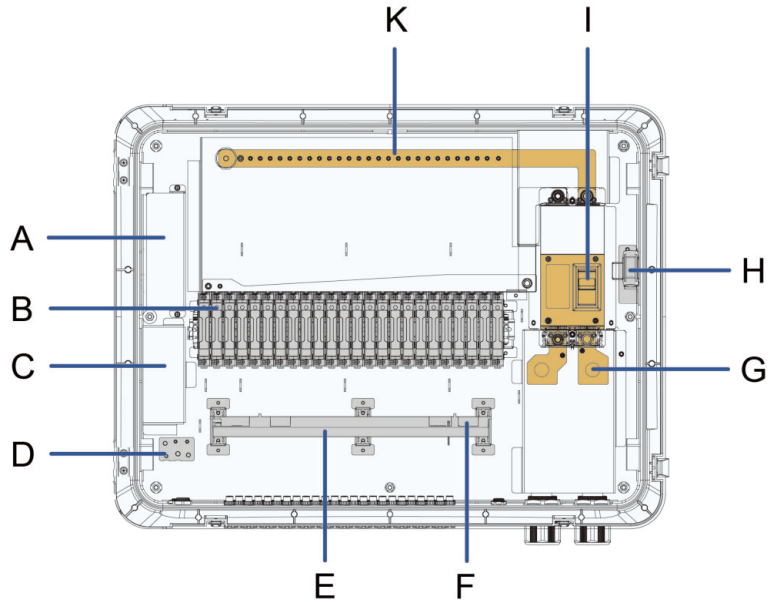

Figure 3-6 Negative fuseless version

* Figures are for reference only. The product received may differ.

No.	Description
A	Power module
B	Positive DC fuse holder and fuse
C	SPD
D	Grounding point, for equipotential connection
E	Monitoring panel
F	RS485 communication terminal
G	DC output wiring terminal
H	Extended handle for operating load switches/circuit breakers
I	Load switch/ Circuit breaker
J	Negative DC fuse holder and fuse
K	Negative copper bar

Monitoring Panel

The monitoring panel monitors the current of each string and uploads the current data to the host computer through RS485 or DC MPLC communication. Users can judge whether modules are faulty by comparing the actual current value with the set value.

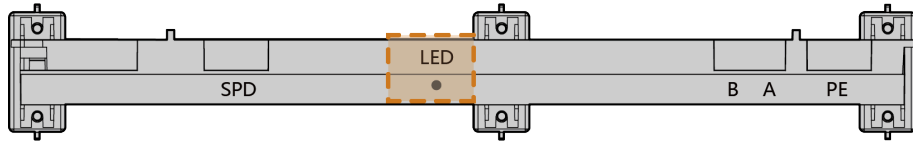

Figure 3-7 LED indicator light

Item	Indicator Status	Definition
Green	Blink	Operating normally
Red	Blink	Fault occurs
	Steady on	Communication Abnormal

When both a fault and a communication anomaly occur, and the LED indicator “blinks” in red, prioritize fault troubleshooting.

SPD (Surge Protection Device)

The PVS is equipped with built-in SPD to prevent transient over-voltage caused by lightning. The SPD failure signal can be sent to the PC through the RS485 or DC MPLC.

Extended Handle

The PVS is equipped with an extended handle inside, inserted into the load switch/circuit breaker, and pulled upwards to close the load switch/circuit breaker.

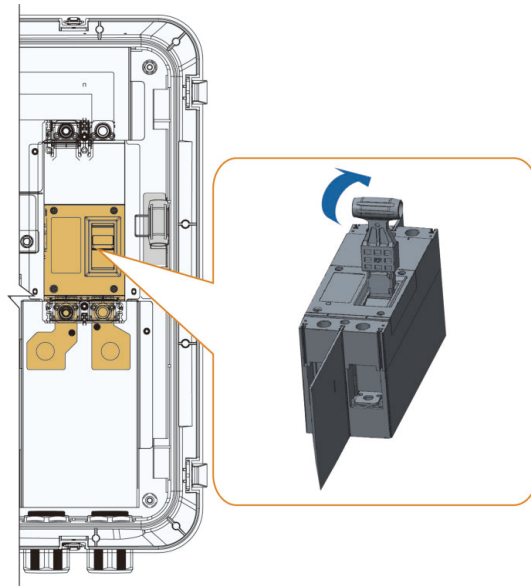

Figure 3-8 Close the load switch/circuit breaker

4 Delivery and Storage

4.1 Scope of Delivery



A



B

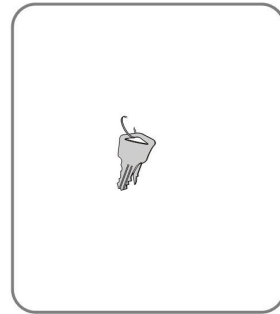

C

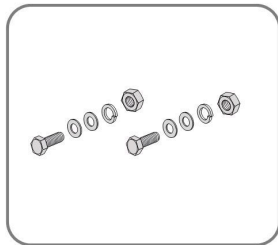

D

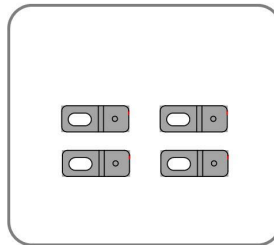

E

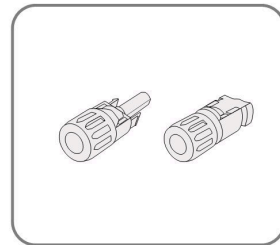

F

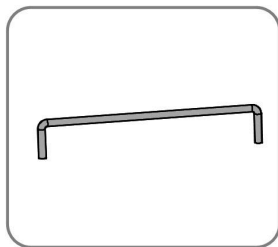

G

No.	Name	Description	Quantity
A	PVS	-	1
B	Related documents	Including certificate, warranty card, factory inspection report, user manual, etc.	1

No.	Name	Description	Quantity
C	Key	To open the cabinet door of the PVS	1
D	Bolt assembly	M5	1
		M8	1
		M16	2
E	Mounting hangers	To fix the PVS to the installation plane	4
F	Special connector for PV cable	To connect the PV input	16 pairs ^{a)} / 18 pairs ^{b)} / 20 pairs ^{c)} / 24 pairs ^{d)}
G	Limit rod	To support the cabinet door when it is open	1

Note :

Parameters noted with a) apply to PVS-16MH[-EH];

Parameters noted with b) apply to PVS-18MH[-EH];

Parameters noted with c) apply to PVS-20MH[-EH];

Parameters noted with d) apply to PVS-24MH[-EH].

Installation tools, cables, and crimping terminals are not included in the delivery scope and need to be provided by the user themselves.

4.2 Checking for Transport Damages

The PVS has been strictly inspected and firmly packed before delivery. Despite robust packaging, the PVS may be damaged during transport.

For this reason, please conduct a thorough inspection after receiving the PVS. Verify at least the following items:

- Check the scope of delivery for completeness according to the packing list.
- Confirm that the model of the PVS and internal equipment received is consistent with your order.
- Check the internal and external components to see if any damage has occurred during transportation.

Contact the forwarding company or SUNGROW in case of any damage or incompleteness.

⚠ WARNING

Only intact and undamaged PVS can be installed and started for commissioning. Ensure the following items before installation:

- **The PVS is in good condition, without any damage.**
- **All internal and external equipment is in good condition, without any damage.**

4.3 Storage

If the PVS is not put into use immediately, store it under specific environmental conditions:

- Store the PVS with outer package in a ventilated, dry, and tidy indoor environment with desiccant retained.
- The storage carrier should be solid enough to bear the weight of the PVS and its outer package.
- The number of stacking layers of PVSs cannot exceed the "stacking layer limit" marked on the outer box.
- The packing box cannot be tilted or turned upside down.
- Ensure that the storage environment is well ventilated and free of moisture and water.
- The storage environment should be at the temperature of $-40\text{ }^{\circ}\text{C} \sim +70\text{ }^{\circ}\text{C}$ and the relative humidity of $0 \sim 95\%$, and free of condensation.
- Pay attention to possible hazards in the surrounding environment, such as sudden temperature changes or collisions, to prevent any damage to the PVS.
- If the PVS has been stored for more than half a year, comprehensive inspection and testing by professionals are required before it can be put into operation.
- Conduct regular inspection, generally not less than once a week. Check that the packaging is not damaged in any way and prevent any damage that may be caused by pests and animals. Replace the packaging immediately if it is damaged.

NOTICE

Storage without packaging is strictly prohibited!
Storage outdoors or in direct sunlight is strictly prohibited!
Tilting the PVS or placing it upside down is strictly prohibited!

NOTICE

After long-term storage, a thorough inspection should be carried out to determine whether the PVS is intact before installation. If necessary, request professionals for testing before installation.

5 Transport and Installation

5.1 Transport

Outer Package Dimensions

Six PVSs are transported as a group. Two PVSs on each layer and three layers in total, as shown in Figure 5-1.

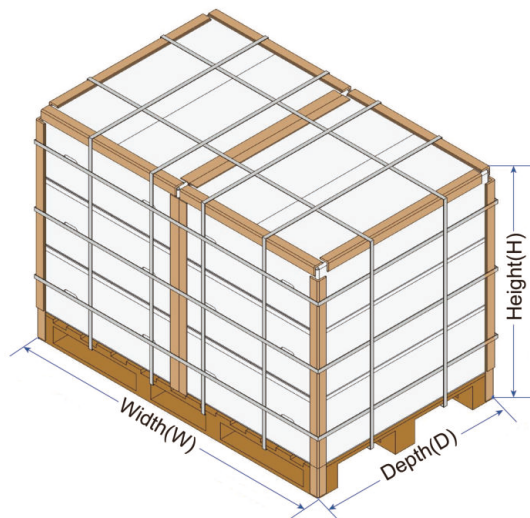

Figure 5-1 Outer package dimensions

Width (W)	Height (H)	Depth (D)
1740 mm	1240 mm	1100 mm

At most two groups can be stacked up and transported as a whole, that is, two PVSs on each layer and six layers in total.

5.2 Installation Environment Selection

The PVS can be installed outdoors or indoors. The following requirements should be met:

- Dimensions and weight of the PVS shall be fully considered when choosing the installation position . Try to install the PVS near PV modules for better work performance and less cable usage.
- The ambient temperature of the installation site should be between $-40\text{ }^{\circ}\text{C}\sim+60\text{ }^{\circ}\text{C}$, and the relative humidity should be between 0~95%. It should be installed in a dry, well-ventilated, and dust-proof place.
- For large-scale utility plant projects, the PVS should be vertically installed in a dark place on mounting brackets of PV modules. Reserve sufficient space around the PVS for better heat dissipation and easier daily maintenance.
- The combiner box is suitable for general outdoor environments with rain and dust protection. However, it is not designed for immersion or flood submersion. Before installation, assess the drainage conditions and historical water level records of the installation site. Do not install the combiner box in low-lying areas where water may accumulate, flow back, or cause submersion (such as cable trenches, basement entrances, and low-lying terrain).

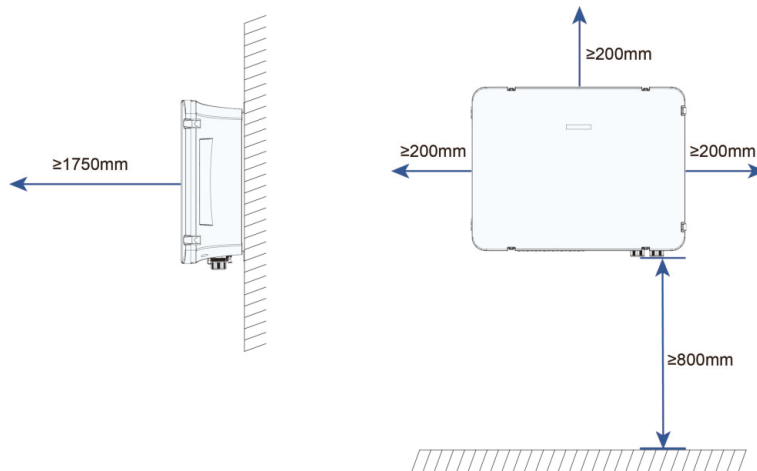









- If the installation location is in an area with a risk of short-term water accumulation or flooding (such as a roof rainwater collection outlet, pit, or area near a waterway), the customer shall take additional protective measures, such as elevated mounting, additional flood barriers, or improved drainage facilities. Ensure that the bottom of the combiner box is at least 800 mm above the highest accumulated water level.

NOTICE

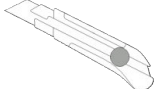
- **Moisture during the installation process will cause damage to the PVS. Do not install the PVS in rainy days or when the air humidity is high.**
- **After installation, the waterproof connectors must be tightened to prevent water vapor from entering. After wiring, the unused terminals must be closed off.**
- **If the customer fails to assess the site environment, selects an improper installation location, does not implement effective waterproofing or drainage measures, or does not take timely emergency protection measures in extreme weather (such as using sandbags or water pumps), water ingress, submersion, corrosion, or damage may occur. The customer shall bear all resulting losses, and SUNGROW shall not be held liable for any quality or installation issues arising therefrom.**

5.3 Preparation Before Installation

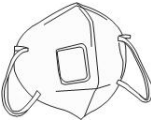
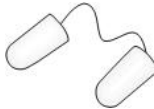
Tools

General Tools			
Marker pen 	Tape 	Level ruler 	Tool knife 
Multimeter Range: ≥1500 Vdc 	Anti-static wrist strap 	Protective gloves 	—
Dust mask 	Sound insulation earplugs 	Goggles 	Insulated shoes 
Vacuum cleaner	Heat-shrink tube	Heat gun	—

General Tools



Installation Tools

φ11 impact drill



M10 electric screwdriver



M10 screwdriver



Wire stripper



Hydraulic clamp



Crimping tool

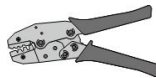

Wrench for special connector for PV cable



Wire cutter

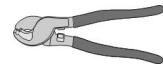

5.4 Installing PVS

The PVS is fixed to the installation plane by hangers. Therefore, ensure that hangers are installed to the back of the PVS before fixing the PVS to the installation plane.

5.4.1 Installing Hangers

Anchor the hangers to the back of the PVS with supplied M10 x 35 bolt assembly, as shown in the figure below.

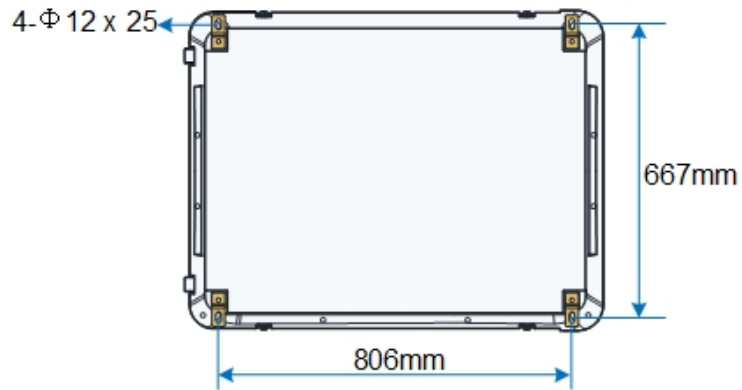

5.4.2 Vertical Installation

Install the PVS on the bracket or the back of the PV module at a suitable height to facilitate future maintenance.

Add washers to compensate for any misalignment between the surfaces of the two beams on the PV module bracket. Ensure the beams remain aligned in the same plane as closely as possible to prevent the deformation of the PVS.

5.4.2.1 Single-post Mounting Structure

Step 1 Mark positions on the back of the PV module according to the distance between the hangers, and drill holes according to the marks.

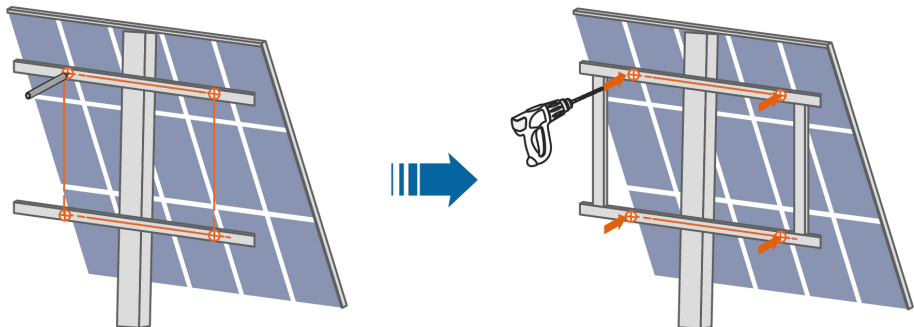

Step 2 Anchor the PVS to the bracket in the sequence shown in the figure below, where the recommended torque is: $51 \pm 0.7 \text{ N}\cdot\text{m}$.

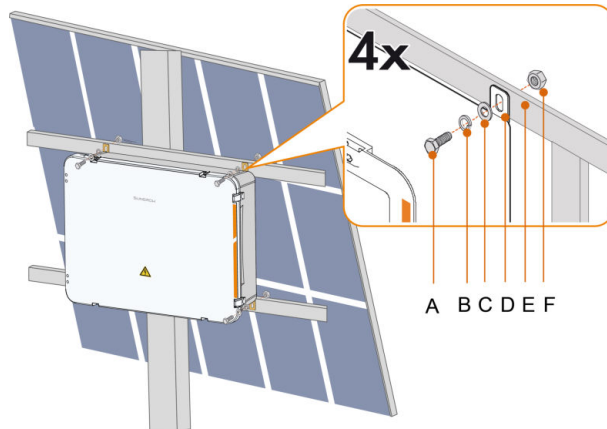

--End

No.	Name	Description
A	M10 bolt	Beyond the scope of delivery
B	Spring washer	Beyond the scope of delivery
C	Flat washer	Beyond the scope of delivery
D	PVS hangers	—
E	PV module bracket	Beyond the scope of delivery
F	Nut	Beyond the scope of delivery

5.4.2.2 Dual-post Mounting Structure

Step 1 Mark positions on the back of the PV module according to the distance between the hangers, and drill holes according to the marks.

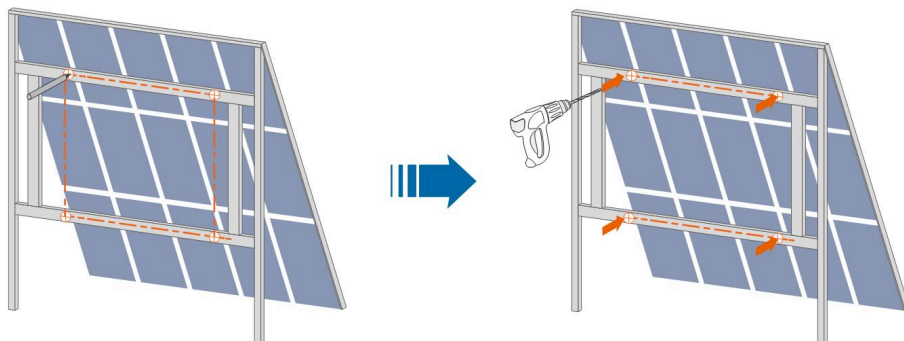

Step 2 Anchor the PVS to the bracket in the sequence shown in the figure below, where the recommended torque is: $51 \pm 0.7 \text{ N}\cdot\text{m}$.

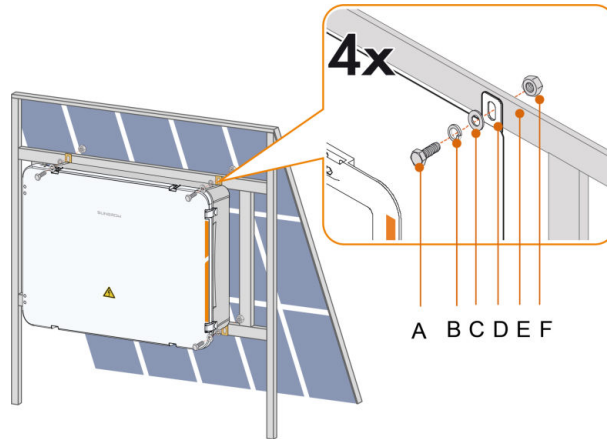

--End

No.	Name	Description
A	M10 bolt	Beyond the scope of delivery
B	Spring washer	Beyond the scope of delivery
C	Flat washer	Beyond the scope of delivery
D	PVS hangers	—
E	PV module bracket	Beyond the scope of delivery
F	Nut	Beyond the scope of delivery

The PVS can be opened or closed through the clasp, the position of the clasp is shown in Figure A below. When installing other components, such as cable guards, make sure that other components do not affect the normal operation of the clasp.

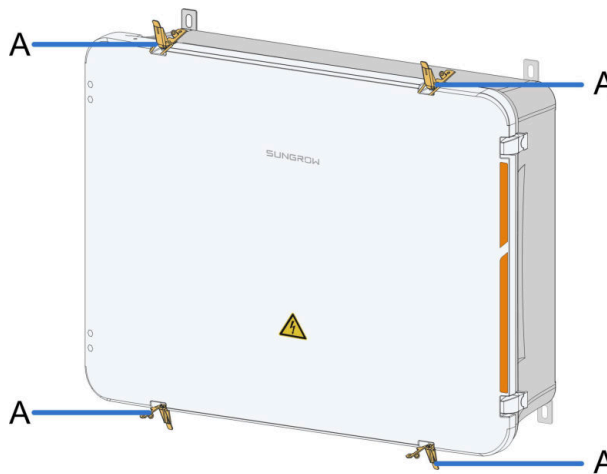

NOTICE

Claps is not closed tightly, the equipment in the PVS may be damaged, or even the PVS may fail.

5.4.2.3 Subsequent Processing (Optional)

If the PVS is installed at the rainwater confluence, a protective cover should be installed on the top of the PVS to avoid rainwater scouring and damage to the PVS.

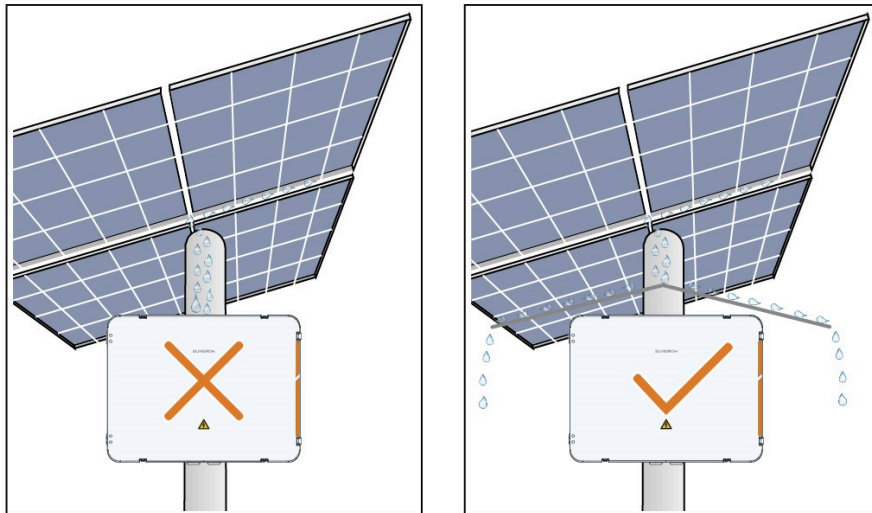
**5.4.3 Horizontal Installation**

Horizontal installation is recommended when the PVS is applied to floating power plants.

5.4.3.1 Installation Requirements

Take into account the below requirements when designing a mounting structure for the PVS:

- Consider the climatic conditions at the site. Take protective measures against rain and snow if necessary.
- Tighten the waterproof connectors at the torques specified in this manual. Ensure the connectors are secure and well-sealed.
- Keep the cables lying naturally straight. Avoid applying stress to the cables.

5.4.3.2 Positioning Hole

When horizontal installation is adopted, it is necessary to fix the positioning holes on the back of the PVS with those on the installation plane (such as bracket).

The distances between positioning holes on the back of the PVS are as shown below.

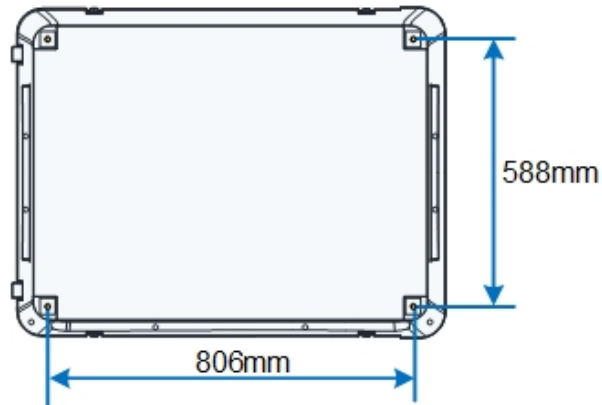

5.4.3.3 Procedure

Step 1 Drill holes in the mounting brackets in advance according to the above distances.

Step 2 Move the PVS onto the brackets and align the positioning holes at the bottom of the PVS with the holes on the brackets.

Step 3 Use M8 x 16 bolt assemblies to secure the PVS to brackets with a tightening torque of 16 N·m. (The specific bolt length can be adjusted according to the actual situation on site.)

--End

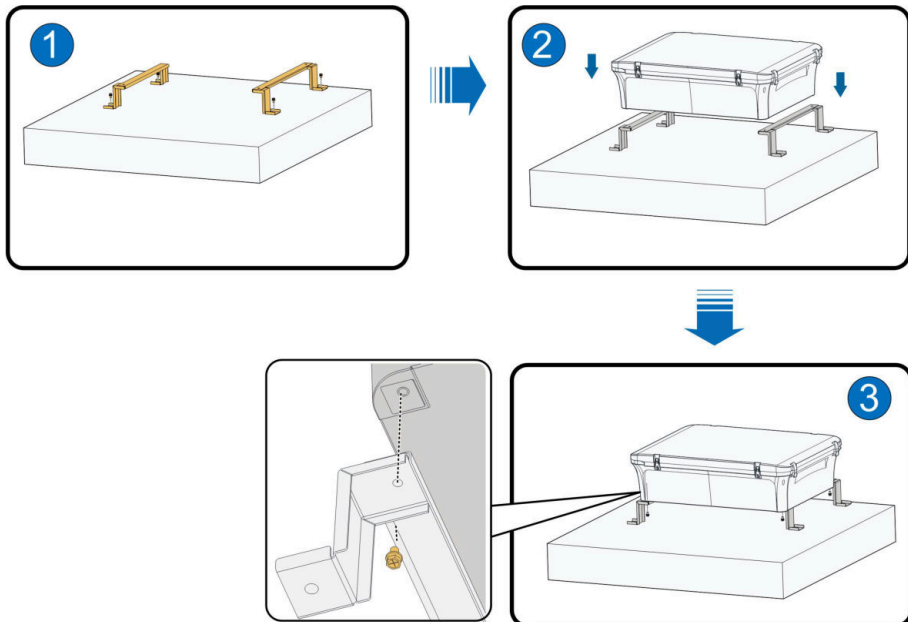

5.4.3.4 Cable Securing and Protection

- The installation angle should meet the specified requirements.
- The waterproof connectors should be ≥ 550 mm off the ground.

- Secure the cables with cable ties at a distance of 300–400 mm from the waterproof connectors. This prevents the connectors from loosening due to stress caused by cable hanging down or swaying, hence avoiding impairing the ingress protection for the PVS.

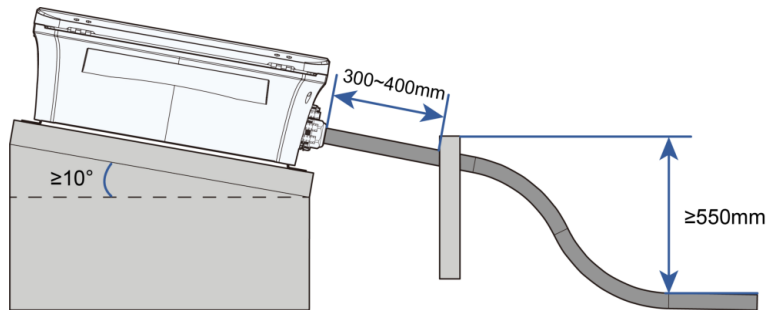

6 Electrical Connection

6.1 Safety Instructions

⚠ DANGER

Electrical Hazard! All operations must only be performed by qualified personnel.

⚠ WARNING

Do not connect the positive and negative cables in reverse. Otherwise, the device may be damaged.

⚠ WARNING

Do not work on the device while it is connected to a load.
Fuse installation and removal must only be carried out when no load is connected.

⚠ WARNING

Disconnect the SPD before performing insulation withstand voltage testing.

NOTICE

Verify that the input voltage is within normal range before powering on.

6.2 Wiring diagram

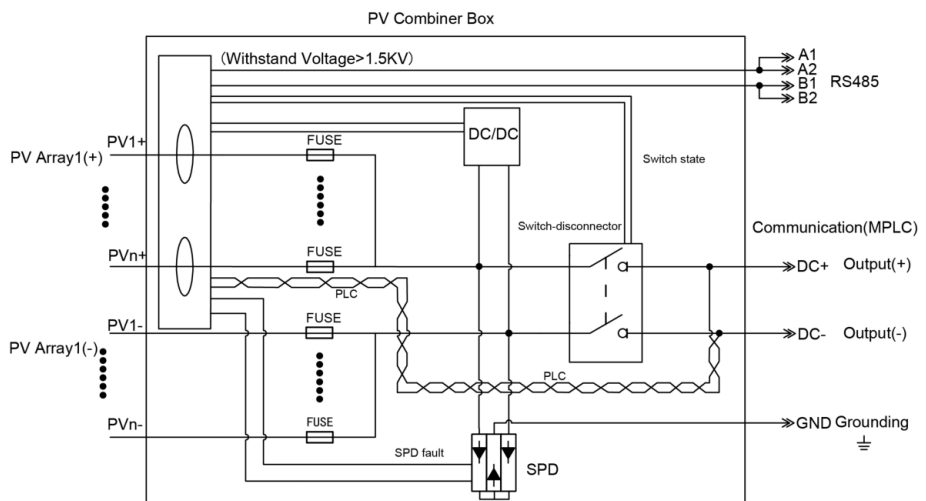

6.3 Preparation before Electrical Connections

6.3.1 Opening Cabinet Door

Prerequisite

NOTICE

To prevent moisture from entering the cabinet, do not open the cabinet door in rainy or snowy days. If it is unavoidable, please take protective measures. To avoid deformation of the limit rod, do not open the cabinet door in windy days.

CAUTION

The PVS-16/18/20/24MH-EH is equipped with an external handle, rotate the handle to the OFF position to power off the PVS before opening PVS Door.

Step 1 Release the two clasps on upper and lower sides of the cabinet door.

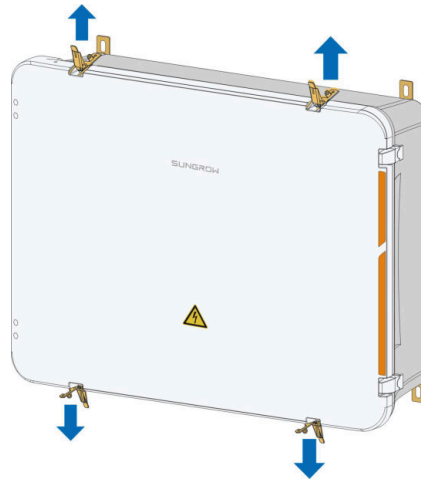

Step 2 Open the door with the door key included in the delivery.

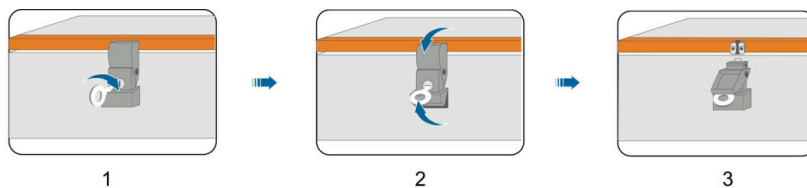

Step 3 Take out the limit rod in the scope of delivery, insert and fix it from the upper side of the cabinet.

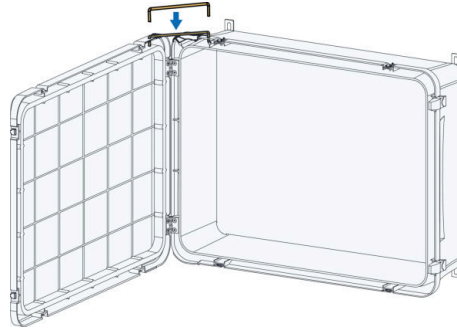

--End

6.3.2 Power-off Preparation

Step 1 Check whether the load switch / circuit breaker of the PVS is in the "OFF" position.

Step 2 Disconnect the fuse. The fuse has been installed in the fuse holder before delivery. Before electrical connection, pull out the fuse holder to disconnect the fuse.

--End

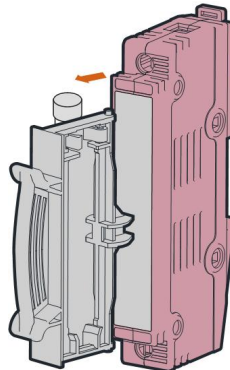

6.3.3 Cable Requirements

Model	PVS-16MH / 18MH / 20MH /24MH
Input cable	Specifications: special connector for PV cable Stripped length: 10 mm Tightening torque:2.5~3 N·m
Output cable	Specifications: 120~400 mm ² (copper wire) flame-retardant cable Stripped length: 35 mm Screw: M16 Tightening torque: 119~140 N·m
Communication cable	Specifications: 2 x 0.75 mm ² ~ 2 × 1.5 mm ² (outer diameter 5 mm ~ 10 mm) shielded twisted pair cable

Model	PVS-16MH / 18MH / 20MH / 24MH
	Stripped length: 7 mm
Grounding cable	Specifications: stranded flame-retardant copper wire with outer diameter of 10 mm ~ 14 mm Stripping length: 15 mm or 25 mm Screw: M5 or M8 Tightening torque: $4.4 \pm 0.4 \text{ N}\cdot\text{m}$ or $20.5 \pm 2.5 \text{ N}\cdot\text{m}$

6.3.4 Cable Layout

Lay cables between the PVS and external devices in cable trenches for easy installation and maintenance. Cable trenches should be designed and constructed in accordance to related regulations, and the quantity and dimensions of devices.

Lay the positive output cable, negative output cable, and communication cable of the PVS in different layers of support arms within the cable trench, as shown in the figure below. This arrangement helps prevent short circuits if the cable insulation is damaged. Users can determine the number of support arms based on their actual needs.

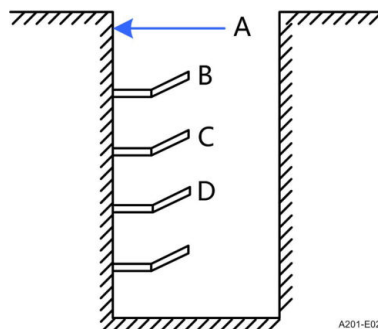

Note: Figures here are for reference only, and users can make adjustment as needed.

No.	Name
A	Cable trench
B	Supporting arm of positive output cable
C	Supporting arm of negative output cable
D	Supporting arm of communication cable

The PVS adopts MPLC communication. Ensure the output cables meet the following requirements during wiring:

- Cables must be laid in cable trenches, trays, or conduits, arranged in parallel without any tangling or knotting as shown in the figure below. Crossovers within the trench, tray, or conduit are not permitted.

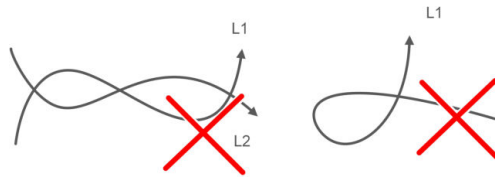

Figure 6-1 Entangled Cables

- To prevent MPLC signals from interfering between DC cables and MV AC cables, which potentially causes signal crosstalk to the DC cables of other sub-arrays and compromising communication reliability, the parallel routing length of the DC and MV AC cables must be limited to less than 3 m.

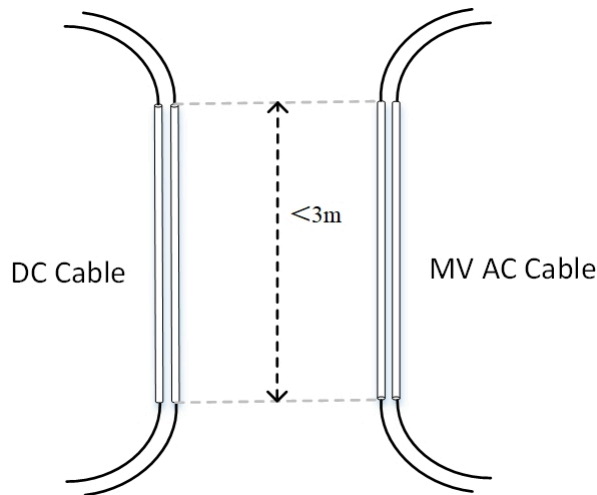

Figure 6-2 Length Requirement for Parallel Routing

- It is recommended to prioritize the use of dual-core cables.
- The maximum supported length for dual-core cables is 1000 m and bundling is not required. For single-core cables, the maximum supported length is 600 m (bundled in pairs or quads, with cable ties spaced every 5 m). Exceeding these length limits may result in communication failures.
- Bundling and Wiring Method.
 - **Single-core cables**
If single-core cables (single cable) are adopted, the cable between the positive and negative poles should be fastened securely every 5 m (as shown in the figure below).

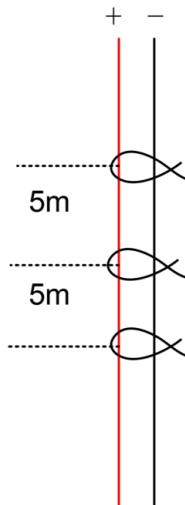

Figure 6-3 Fastening of Single-core Cables (Single Cable)

If single-core cables (paired cable) are adopted, each pair of cables between the positive and negative poles should be fastened securely every 5 m (as shown in the figure below).

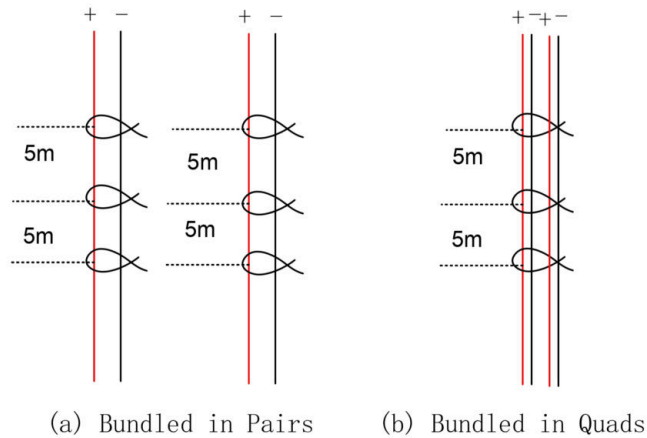

Figure 6-4 Fastening of Single-Core Paired Cables

If single-core paired cables are adopted, the maximum allowable length difference between a pair of cables is 5 m.

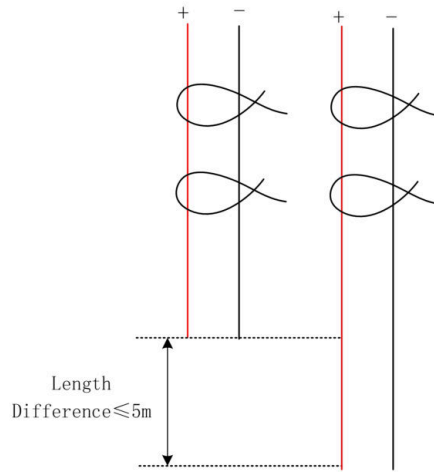

Figure 6-5 Length Difference Requirements for Single-Core Paired Cables

- **Dual-core cables**

If dual-core paired cables are adopted, the maximum allowable length difference between two pairs of cables is 10 m (as shown in the figure below). When the unequal length of two sets of cables exceeds the limit, it will cause communication interruption.

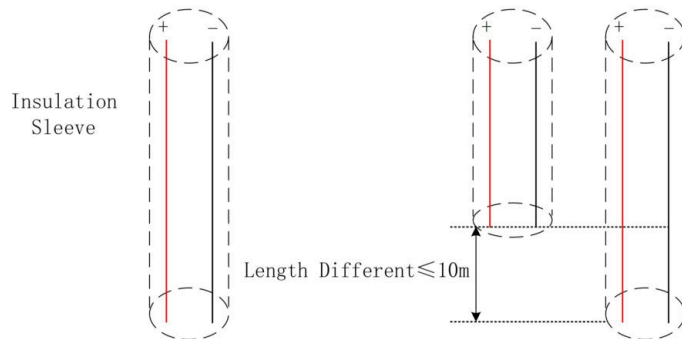

Figure 6-6 Cable Length Difference Requirements for Paired Cable

As shown in the figure below, the positive and negative cables must be connected in a crossed manner. To ensure reliable MPLC communication, please adhere to SUNGROW technical requirements during construction. Failure to do so may cause power plant communication instability. SUNGROW shall not be held liable for any resulting communication issues due to non-compliance with SUNGROW requirements.

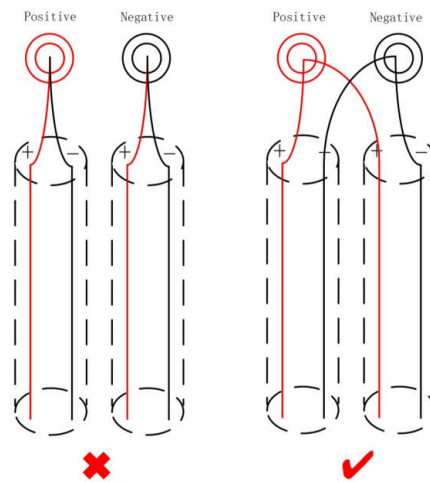
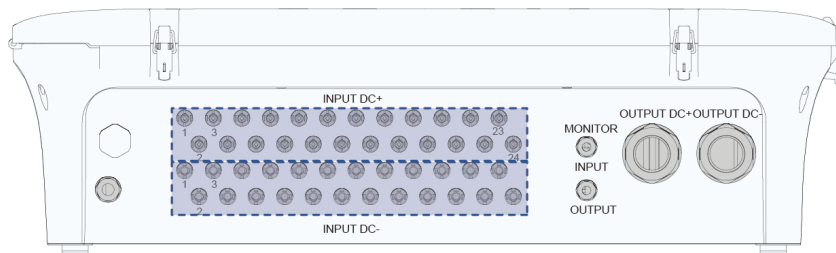



Figure 6-7 Correct and Incorrect Connections

6.3.5 Waterproof Connector and Cable Specification

Waterproof Connector and Cable Specification



Marks	Description	Model	Cable Outer Diameter (mm)
INPUT DC+	Positive input	Special connector for PV cable	4.7 ~ 6.4
INPUT DC-	Negative input	Special connector for PV cable	
MONITOR INPUT	Communication input	PG-11	5 ~ 10
MONITOR OUTPUT	Communication output		
	Grounding	PG-16	10 ~ 14
OUTPUT DC+	Positive output	M50-A/M50-B	20~30/30~42

Marks	Description	Model	Cable Outer Diameter (mm)
OUTPUT DC-	Negative output		

If no waterproof connectors are used, use a plug cap to seal the gap.

6.4 Input Connections

6.4.1 Safety Precautions

⚠ DANGER

There is a high voltage in the PV string. Accidental contact may cause fatal electric shock or severe burns. When wiring the PVS, observe the following safety precautions:

- Before wiring, please disconnect the end of the PV string.
- Before wiring, do not use an ordinary multimeter to measure the DC voltage. A multimeter with a withstand voltage of at least 1500 V is recommended. Otherwise, serious damage may follow.
- Please follow all safety instructions of the PV module manufacturer.

⚠ WARNING

Incorrect cable connection can cause damage to PV modules, the PVS, and inverters. When wiring, observe the following precautions:

- Wire according to the wiring drawing.
- Measure the voltage of positive and negative polarities of each string by a multimeter with a withstand voltage of at least 1500 V and ensure there is no reverse connection before wiring;
- Distinguish the positive and negative polarity of strings before wiring, and ensure that there is no ground fault.
- Star-shape wiring is not supported on site.

6.4.2 Special Connector for PV Cable

Step 1 Strip off the insulation layer of 10 mm from the positive and negative DC cables.

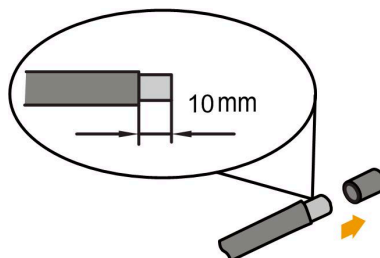

Step 2 Crimp the metal contacts onto the stripped wires using a crimping tool.

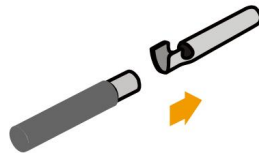

Step 3 Connect the cables as shown below. Pull the cable gently to make sure it is secured.

—Connect the positive input cable as shown below.

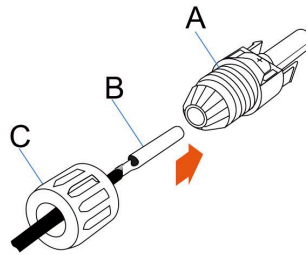

A	B	C
Positive input connector	Positive Input cable	Sealing cover

—Connect the negative input cable as shown below.

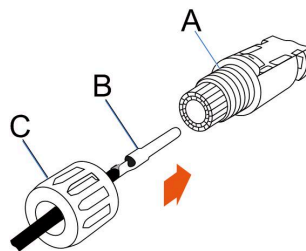

A	B	C
Negative input connector	Negative Input cable	Sealing cover

Step 4 Gently pull the cable backward to ensure firm connection. Tighten the cable gland and the insulator (torque 2.5 N·m to 3 N·m).

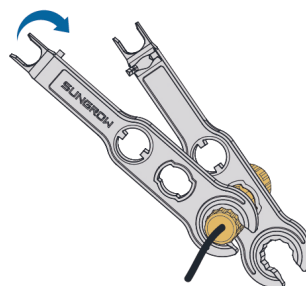

Step 5 Connect the PV connectors to corresponding terminals until there is an audible click.

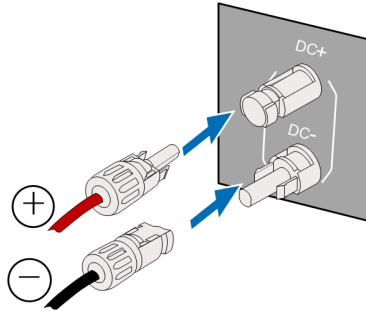

Step 6 Connect other PV terminals according to the above steps.

Step 7 Seal the unused PV terminals with the special connector for PV cable compatible waterproof caps.

--End

⚠ WARNING

After wiring, it is strictly prohibited to seal the gap between cables and the special connector for PV cable with fireproof mud.

6.5 Output Connections

Preparation Before Wiring

Unscrew the waterproof connectors at the DC output port of the PVS.

Open the protective cover of the output terminals.

Overview of Wiring Area

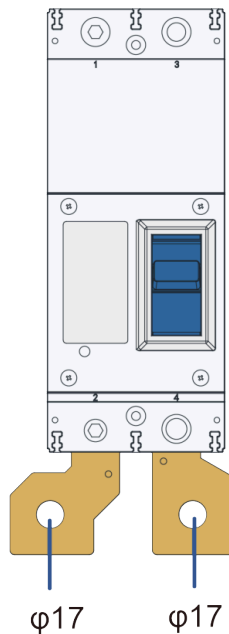

Note: The figure is for reference only and the actual product shall prevail.

Step 1 Lead the "DC+" cable through the "OUTPUT DC (+)" waterproof connector. Enough cable bending space should be ensured.

Step 2 Strip the protective layer and insulation layer of the cable to expose the copper core of $L \approx 25$ mm, crimp the cable to the appropriate DT terminal, and tighten them with a heat shrinkable tubing.

It is recommended to use heat shrinkable tubing with a voltage not lower than 10 kV.

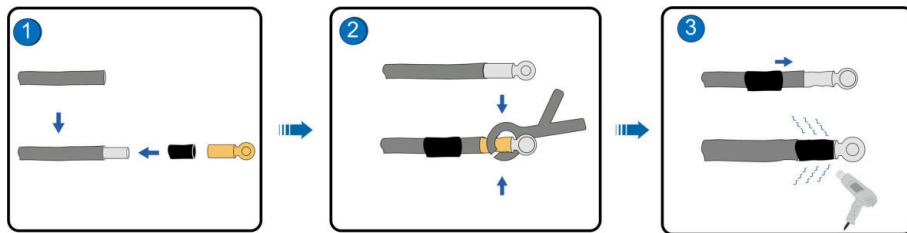

Step 3 Fix the crimped DT terminal to the output terminal.

When copper wire is used, fix the DT terminal to the output terminal in an order shown in the figure below, and the tightening torque is 119~140 N·m.

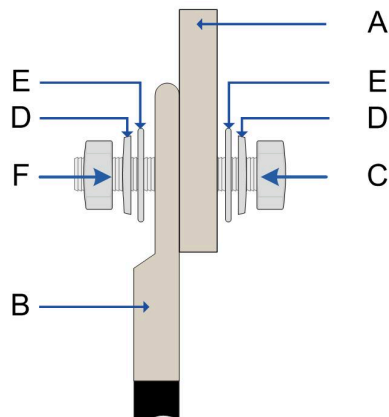

Figure 6-8 Schematic of copper wire connection

A	B	C	D	E	F
Copper bar	Copper terminal	M16 bolt	Spring washer	Flat washer	Nut

When aluminum wire is used, fix the DT terminal to the output terminal in an order.

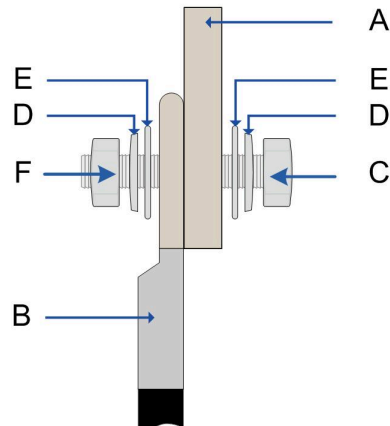

Figure 6-9 Schematic of aluminum wire connection

A	B	C	D	E	F
Copper bar	Copper-aluminum transition terminal	M16 bolt	Spring washer	Flat washer	Nut

Step 4 Tighten the nut of the waterproof connector clockwise.

⚠ WARNING

Make sure that fastening screws on terminals are fastened in place. If the copper core has not been fully and tightly contacted with the wiring terminal, long-time work may burn the terminal.

Use stranded copper core flame-retardant cables with the wire diameter not less than the recommended value in the appendix.

Fasten screw caps of waterproof connectors in place, otherwise, it may cause water leakage and damage to the PVS.

--End

6.6 Ground Connection

Brief Introduction

⚠ WARNING

The grounding cable must be well connected to ground, otherwise:

- It may cause fatal electric shock to the operator in case of failure!
- The equipment may be damaged when struck by lightning!

NOTICE

Relevant standards and regulations must be observed.

- Grounding cables must be connected firmly with both the device and ground terminals.
- The ground resistance shall be measured after the ground connection is finished, and its resistance value shall be no more than 1 Ω .

Grounding Hole

There are grounding holes reserved for M5 and M8 riveting screws in the PVS, as shown in the figure below.

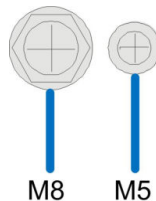

On site, select the appropriate grounding holes according to actual conditions.

Table 6-1 Wiring requirements

Riveting Screw Specifications	M5	M8
Recommended cable specifications	16 mm ²	95 mm ²
Stripping length L	15 mm	25 mm
Tightening torque	4.4±0.4 N·m	20.5±2.5 N·m

Connection Method

- Step 1** Loosen the nut of grounding waterproof terminal.
- Step 2** Lead the yellow green cable through waterproof terminal, leaving a proper margin in cable length.
- Step 3** Use wire strippers to strip the protective layer and insulation layer of the cable to expose the copper core of the wire. For the specific stripping length, refer to [Table 6-1 Wiring requirements](#).
- Step 4** Crimp the OT terminal.

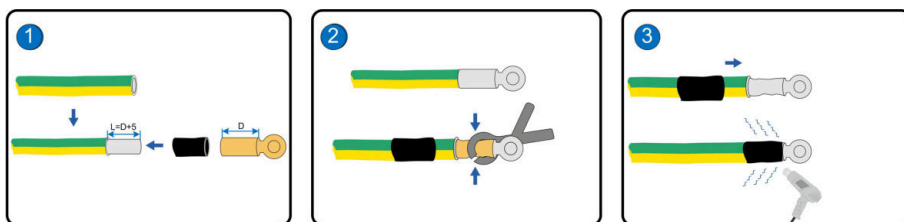

Step 5 Fix it to the ground copper bar in the sequence of screw, spring washer, flat washer, OT terminal, and grounding hole. Refer to [Table 6-1 Wiring requirements](#) for the tightening torque.

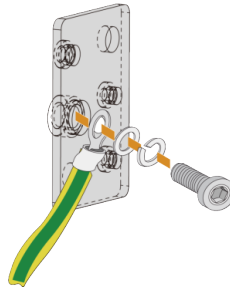

Step 6 Tighten the nut of the waterproof terminal clockwise.

--End

6.7 Communication Connection

6.7.1 Communication Solution

RS485 Communication

The PVS adopts series RS485 communication, as shown in the following figure.

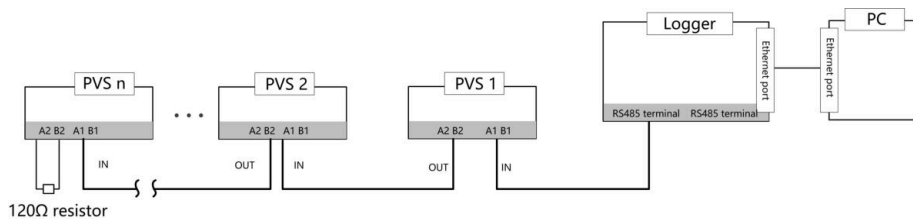

- A1 and B1 of PVS 1 are connected to A1 and B1 of the logger;
- A2 and B2 of PVS 1 are connected to A1 and B1 of PVS 2;
- A2 and B2 of PVS 2 are connected to A1 and B1 of PVS 3;

And so forth, A2 and B2 of the PVS n-1 are connected to A1 and B1 of PVS n.

NOTICE

The 120 Ω resistor shown in the figure above is not a required item. If on-site communication is poor, it is recommended to connect a resistor to the last device on the RS485 bus to improve the communication quality. For example, connect a resistor between the RS485-A and RS485-B of PVS n in the above picture. If the communication quality is not improved, check whether the cable routing meets requirements. For details, please refer to [6.3.3 Cable Requirements](#).

DC MPLC communication (optional)

The PVS adopts series DC MPLC communication, as shown in the following figure.

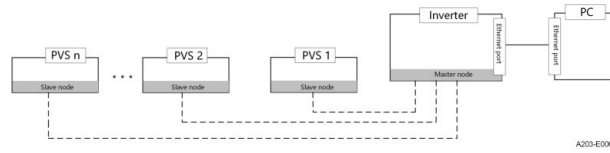

- The client node of the first PVS communicates with the host node of the inverter;
- The client node of the second PVS communicates with the host node of the inverter.

And so on, all PVS client nodes communicate with the host nodes of the inverter.

NOTICE

The monitoring panel only works when the PV string voltage reaches the rated working voltage of the switching power supply of the PVS.

NOTICE

After installation or maintenance, ensure the door is locked and the key cover is fully closed to avoid water penetration.
Sufficient bending space for each cable should be reserved, and cables must not be tightened and stressed.

6.7.2 RS485 Communication Wiring

Prerequisite

The RS485 communication terminals inside the PVS are shown below.

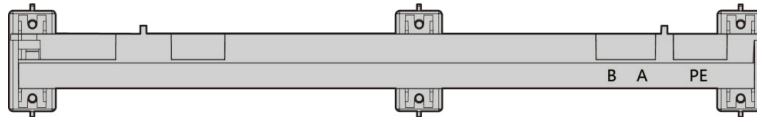

The specification of RS485 communication cable should be 2 x (0.75 to 1.5) mm².

- Step 1** Loosen the “MONITOR INPUT” and “MONITOR OUTPUT” waterproof connectors on the PVS.
- Step 2** Pass the communication cable through the waterproof connector into the PVS.
- Step 3** Strip the protective layer of the cable and the insulation layers of the wires to expose approximately 8 mm of copper cores.
- Step 4** Connect the copper core to the adapter terminal block and tighten the terminal with a screwdriver. The rules are:
 - Connect RS485–A to A1;
 - Connect RS485–B to B1;
 - Connect cable shield to PE.
- Step 5** Connect the wires of the output cable to A2, B2, and PE terminals in the same way.

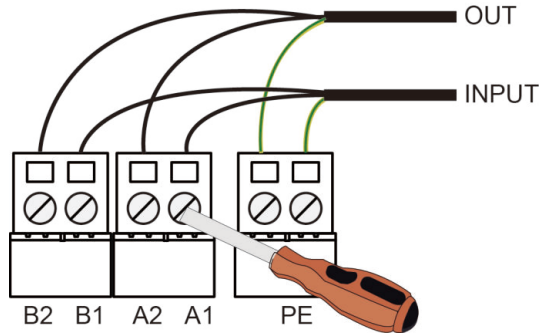

Step 6 Insert the adapter terminal into the terminal block of the monitoring board to complete the wiring of the RS485 communication.

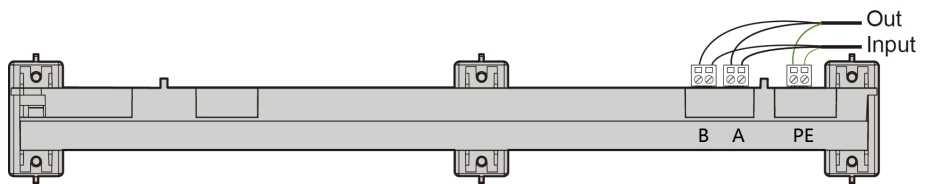

NOTICE

Use a shielded twisted pair as the communication cable, to avoid unstable communication or communication failure.
Keep communication cables away from high-voltage cables. Do not run communication cables in parallel with power cables or tie them together, as this may cause communication interruptions and damage the product. If this is not possible, route the communication cables through galvanized conduit for shielding.

--End

6.8 Subsequent Processing

After all wiring is completed, for the unsealed PG waterproof connector, use fireproof material to seal off the gaps around the PG waterproof connector from the inside of the PVS.

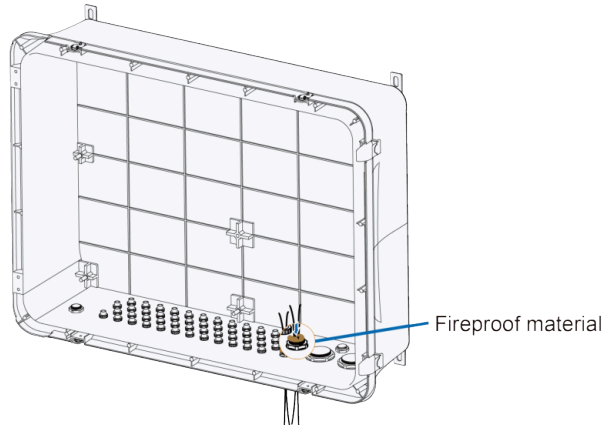

NOTICE

Blocking the waterproof vent valve may cause condensation in the PVS and even damage the equipment inside the PVS.

Inspection

After electrical connections are completed, inspect the wiring thoroughly and carefully.

⚠ WARNING

- **Check that the cables are all connected properly.**
- **Check that the protective cover is installed, the waterproof connectors are tightened, and the doors are locked.**
- **Gaps between the waterproof connector and the cable are sealed off using fireproof mud.**

Performance Requirements for Firestop Sealant Materials

- Apparent density $\leq 1.6 \times 10^3 \text{ kg/m}^3$
- When immersed in tap water at $20 \text{ }^\circ\text{C} \pm 5 \text{ }^\circ\text{C}$, the material must maintain integrity for ≥ 3 days without swelling or cracking.
- When immersed in a 3% ammonia solution at $20 \text{ }^\circ\text{C} \pm 5 \text{ }^\circ\text{C}$, the material must maintain integrity for ≥ 3 days without swelling or cracking.
- When immersed in a 3% hydrochloric acid solution at $20 \text{ }^\circ\text{C} \pm 5 \text{ }^\circ\text{C}$, the material must maintain integrity for ≥ 3 days without swelling or cracking.
- When placed in an environment with relative humidity $90 \% \pm 5 \%$ and temperature $45 \text{ }^\circ\text{C} \pm 5 \text{ }^\circ\text{C}$, the material must maintain integrity for $\geq 360 \text{ h}$ without cracking or powdering.
- When subjected to freeze-thaw cycles consisting of immersion in water at $23 \text{ }^\circ\text{C} \pm 2 \text{ }^\circ\text{C}$ for 18 h, freezing at $-20 \text{ }^\circ\text{C} \pm 2 \text{ }^\circ\text{C}$ (starting the 3-hour period once the material reaches $-18 \text{ }^\circ\text{C}$), and subsequent exposure to $50 \text{ }^\circ\text{C} \pm 2 \text{ }^\circ\text{C}$ for 3 h, the material must withstand ≥ 15 cycles without cracking or powdering.

- The material must meet B2 grade requirements for combustion performance according to GB 8624.
- The material must limit toxic gas emissions to meet at least ZA2 grade according to GB/T 20285.
- The material must have air permeability $\leq 3.5 \text{ m}^3/(\text{m}^2 \cdot \text{h})$.
- For overseas firewall versions, the material must maintain fire resistance integrity (Fr) $\geq 3.0 \text{ h}$; the backing cotton pad must not ignite, flame duration must not exceed 10 s, and probe must not penetrate any gaps.
- The material must maintain fire insulation (Fi) $\geq 3.0 \text{ h}$. Temperature rise at any point on the unexposed side and frame surface must not exceed 180 °C.
- After fire resistance testing, the material must not develop any holes that allow water flow on the unexposed side during water spray testing.
- In addition to complying with the national standards of the country of use, foam sealants and fireproof mud must not release corrosive gases such as chlorine, ammonia, or sulfur under operating temperatures of -40 to 85°C. Halogen-free and environmentally friendly sealing materials must be used.

7 Commissioning

Follow the steps below to check whether the PVS operates normally after installation:

PVS-16/18/20/24MH

1. Measure the input voltage between positive and negative polarities of each input to make sure they are basically same and there is no reverse connection.
2. Fasten the fuse holder, the PVS has been powered on.
3. Check whether the indicators on the power board and monitoring board are on.
4. Measure the output voltage between positive and negative polarities of each output to make sure they are basically same and there is no reverse connection.
5. Close the load switch / circuit breaker.
6. Secure the clasps.
7. Lock the door.
8. Pull out the key.
9. Complete commissioning.

PVS-16/18/20/24MH-EH

1. Measure the input voltage between positive and negative polarities of each input to make sure they are basically same and there is no reverse connection.
2. Fasten the fuse holder, the PVS has been powered on.
3. Check whether the indicators on the power board and monitoring board are on.
4. Measure the output voltage between positive and negative polarities of each output to make sure they are basically same and there is no reverse connection.
5. Secure the clasps.
6. Lock the door.
7. Pull out the key.
8. Rotate the external handle to the ON position.
9. Complete commissioning.

NOTICE

- **After completing the commissioning, proceed with PVS communication setup and parameter configuration. For detailed instructions, refer to [8 PVS Function Settings](#).**
- **verify that the string access status for each PVS is correctly configured. If not, refer to [8.4.1 String Access Settings](#) for proper setup instructions.**

8 PVS Function Settings

8.1 Device Introduction

The PVS supports functions such as address change and one-click trip via the inverter SCU or the iConfig.

Users can quickly set the PVS communication network via SCU of the inverter.

8.1.1 WEB

Although the antenna module is integrated on the main control board inside the PVS enclosure, the product does not support Wi-Fi functionality due to software limitations.

8.1.1.1 Preparation Before Login

Users can access the SCU WEB interface on the PC.

Step 1 Connect the PC to the commissioning network port on the SCU with a network cable.

Step 2 Configure the IP address of the PC. Set the IP address of the PC to the same network segment as the NET address of the SCU.

Default IP address of the NET1 port: 12.12.12.12.
Default IP address of the NET2 port: 14.14.14.14.

--End

8.1.1.2 Login Steps

For login steps, refer to the SCU manual.

Manual	Source
SCU1100 User Manual	https://support.sungrowpower.com/Document

8.1.2 iConfig

8.1.2.1 Preparation Before Login

iConfig Installation Package

Step 1 Please contact SUNGROW support team for the iConfig installation package.

Step 2 After installation, click **Device identifier export** on the login interface to copy the device identifier.

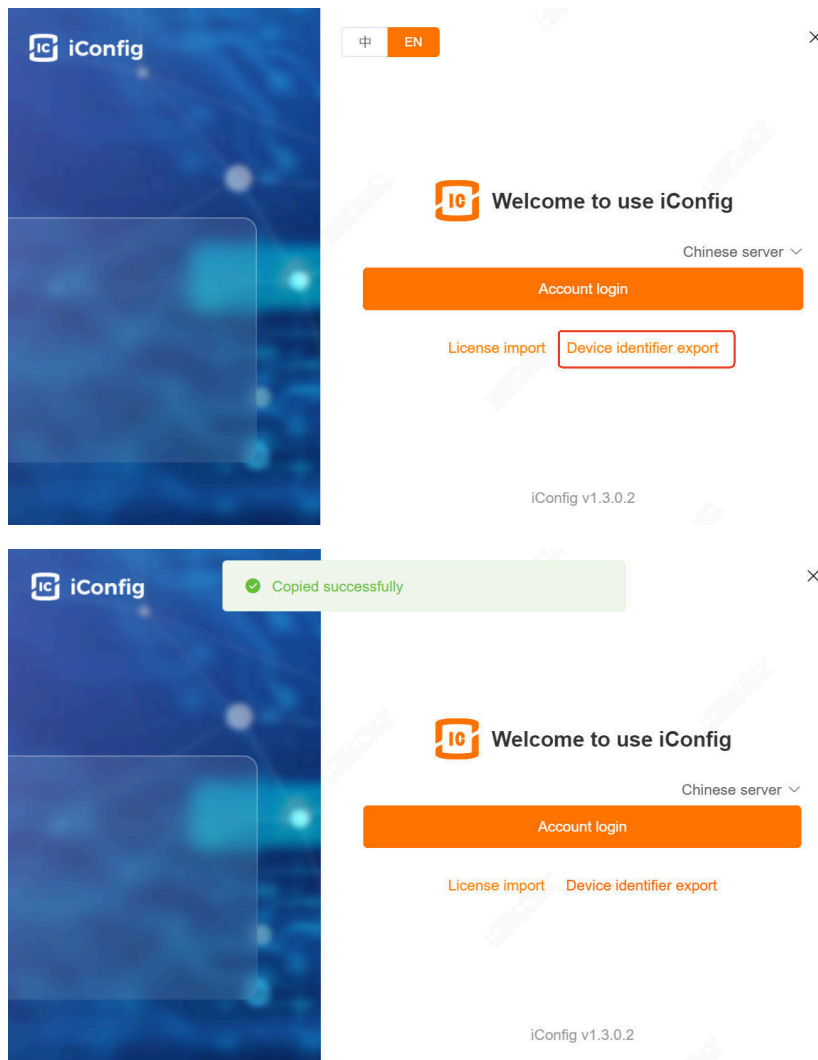

Step 3 Send the successfully copied device identifier to SUNGROW support team to obtain the iConfig license. Once received, click **License import** to activate it.

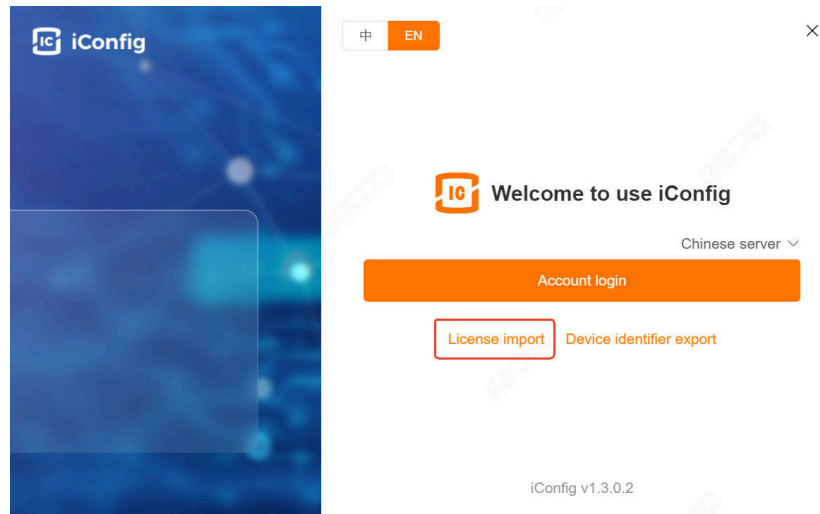

Step 4 You can enter iConfig after importing the license.

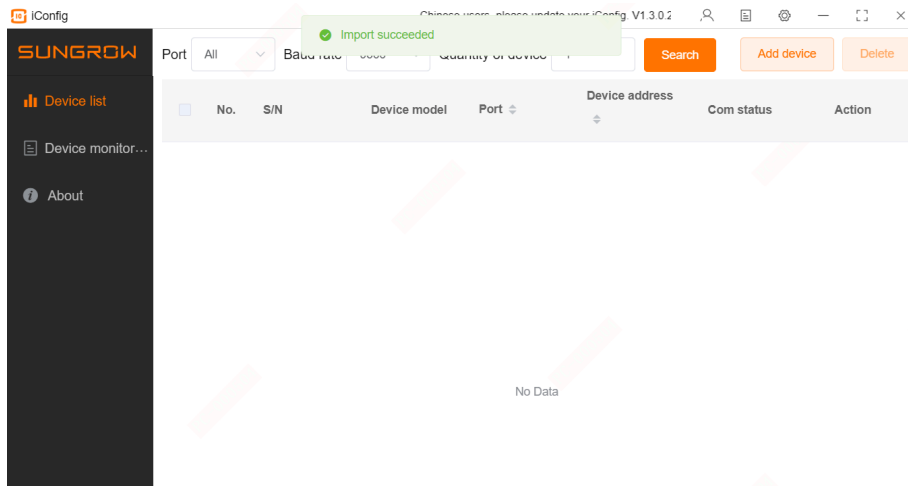

--End

8.1.2.2 Login Steps

Step 1 Connect the PVS using a USB-to-RS485 converter.

Step 2 Open iConfig, select the COM port connected to your PC, set the baud rate to 9600, enter the number of connected devices, and click Search.

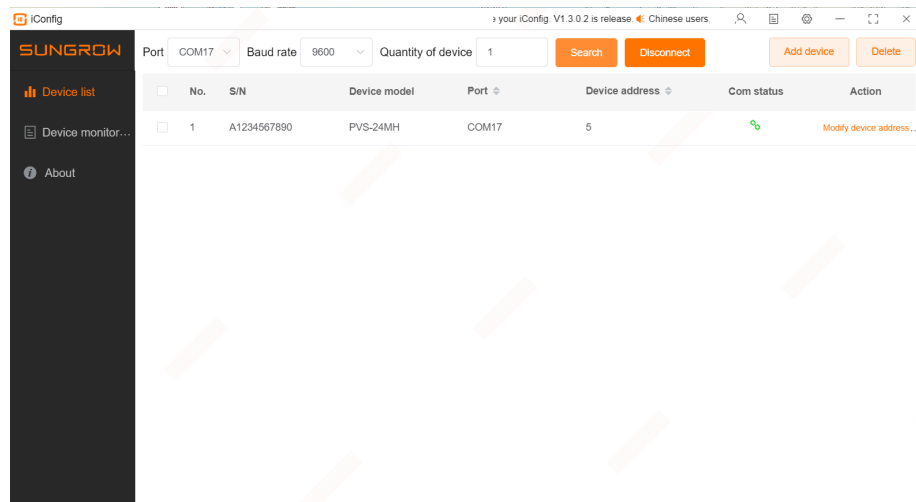
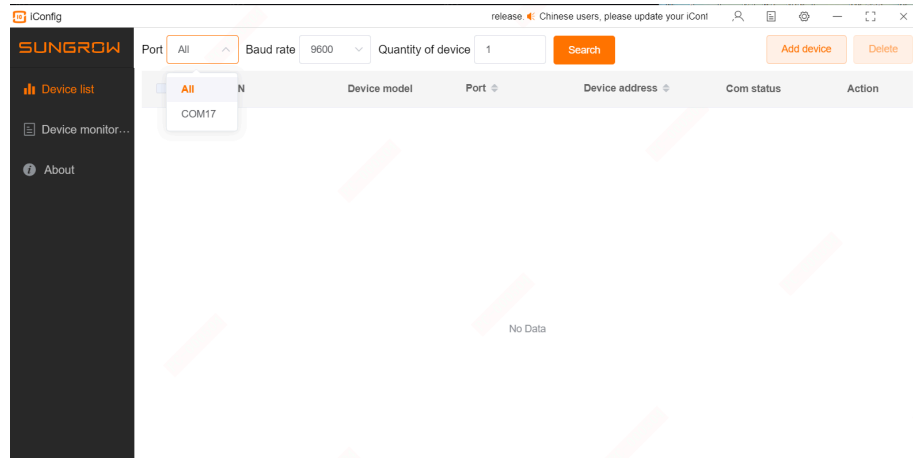

--End

8.2 PVS Communication Settings

8.2.1 Quick Networking

SUNGROW 1+X series inverters support quick networking of the PVS via the web interface. Depending on the on-site communication method, quick networking can be achieved through either RS485 auto search.

When using quick networking, note that device addresses are assigned automatically. Therefore, it's essential to predefine the mapping between PVS SNs and device addresses to ensure accurate correspondence between each PVS and its physical location.

8.2.1.1 RS485 Auto Search

Rapid networking of the PVS can be achieved via RS485 auto search.

If the auto-assigned addresses do not meet on-site requirements, the addresses can be manually configured according to [8.2.1.2 Change PVS Address](#).

Step-by-Step Instructions

Step 1 Log in to the SCU interface and click **Device List > Auto Search**.

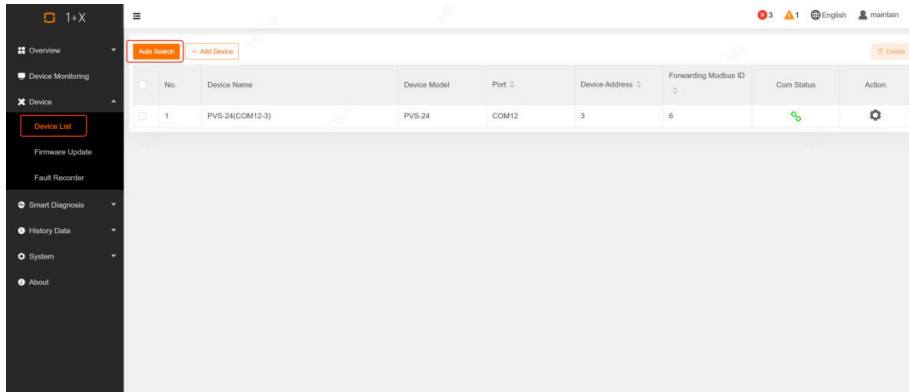

Step 2 Select the RS485-connected port for device search.

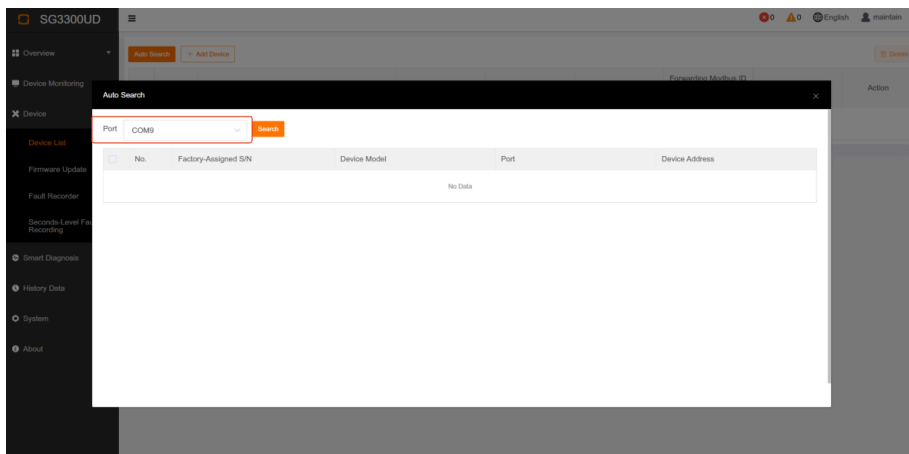

Step 3 The interface will be unresponsive during the search. After completion, all online devices will be listed.

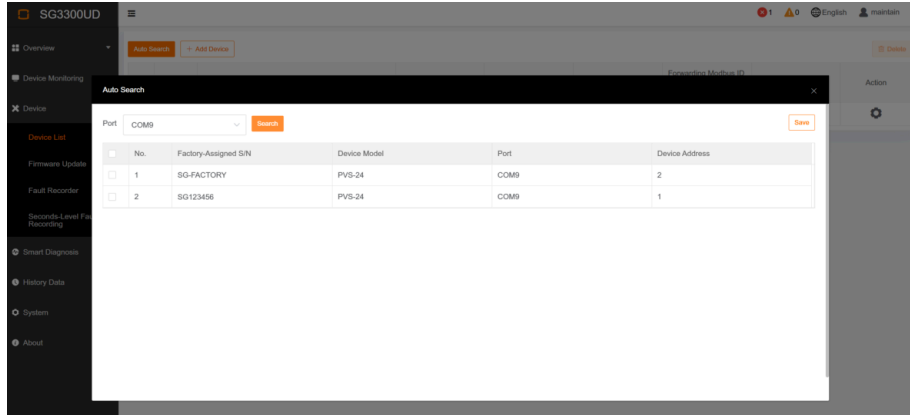

Step 4 If no address conflicts are detected, simply select the devices and click **Save**. If conflicts exist, a pop-up will indicate duplicate addresses, then click **Continue** to auto-assign new ones.

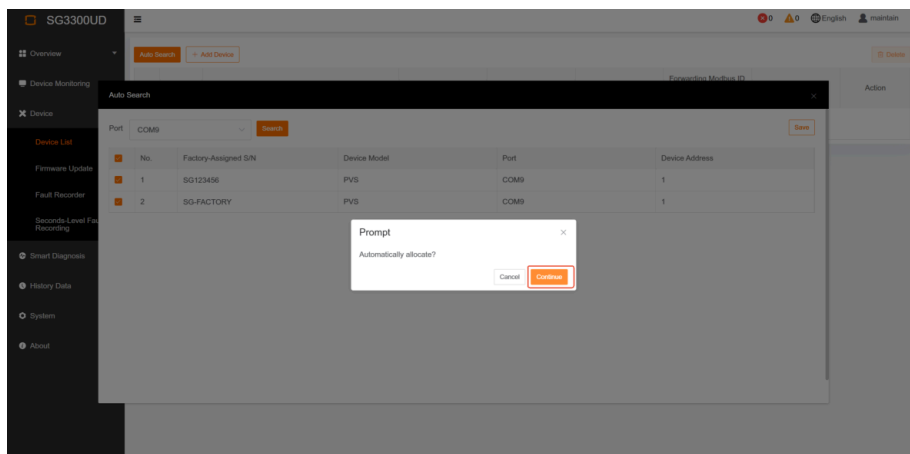
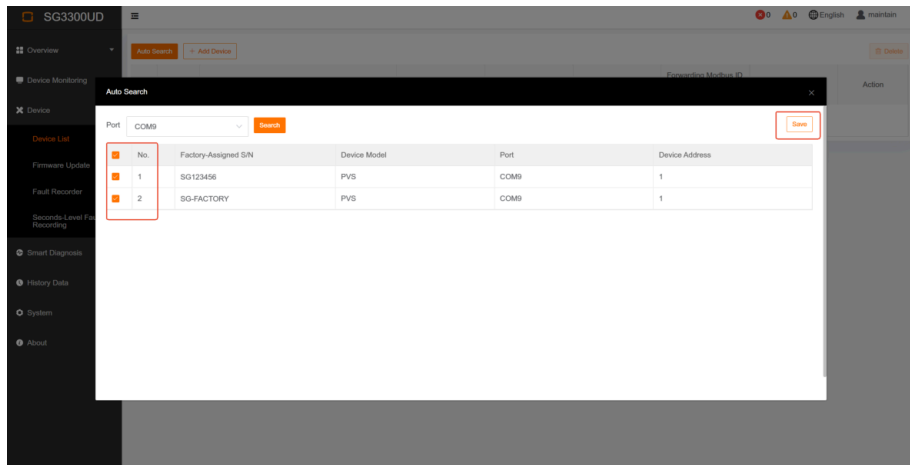

Step 5 The auto-assigned addresses are shown as follows.

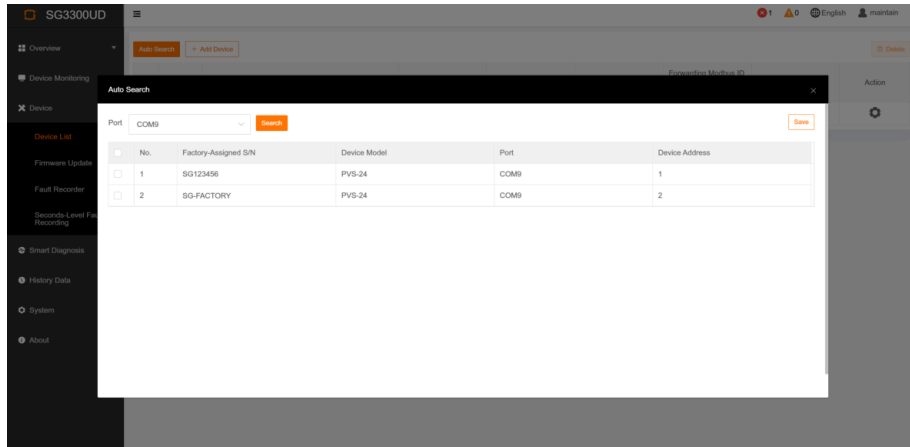

--End

8.2.1.2 Change PVS Address

Users can change the PVS address via SCU.

Step-by-Step Instructions

Step 1 Log in to the SCU interface, click **Device > Device List** on the interface, and click the **Action** button.

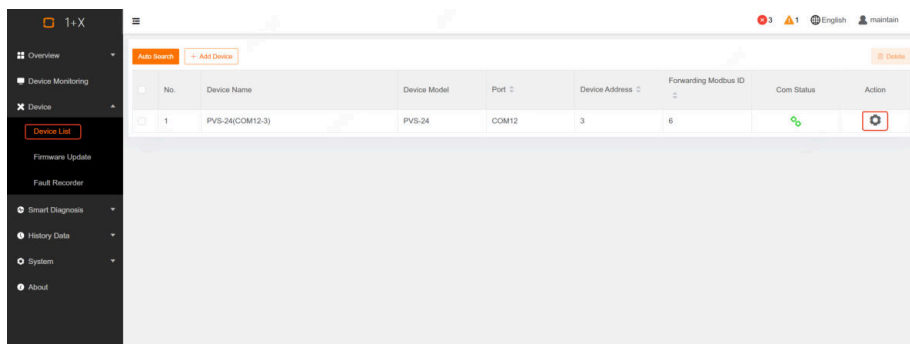

Step 2 Change the **Device Address** (1-231)

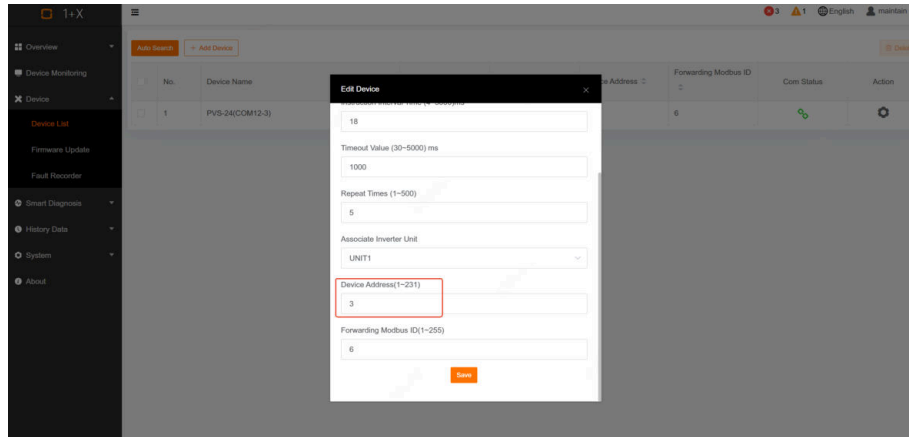

--End

When changing an address, make sure the new address does not conflict with any existing ones. If the target address is already in use, change it to another one until it meets the on-site requirements.

8.2.2 iConfig Local Access Address Settings

Step 1 Select the device that requires address change, and click **Modify device address**.

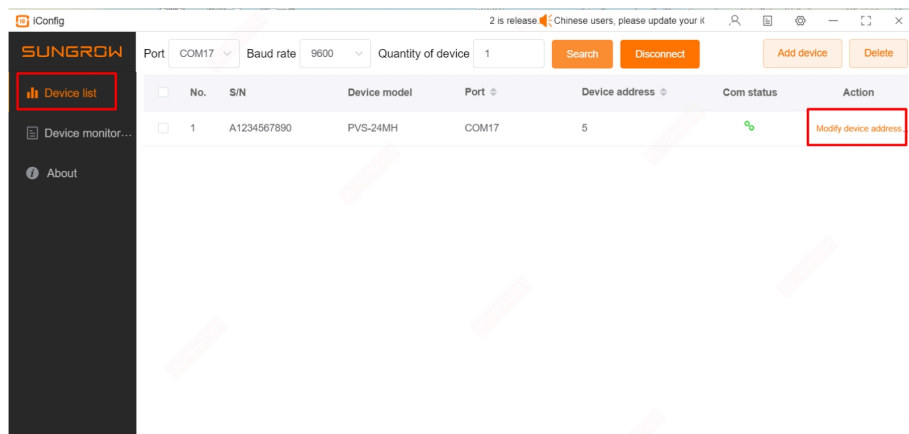

Step 2 Enter the target device address (1-231), and click **Confirm** to complete the change.

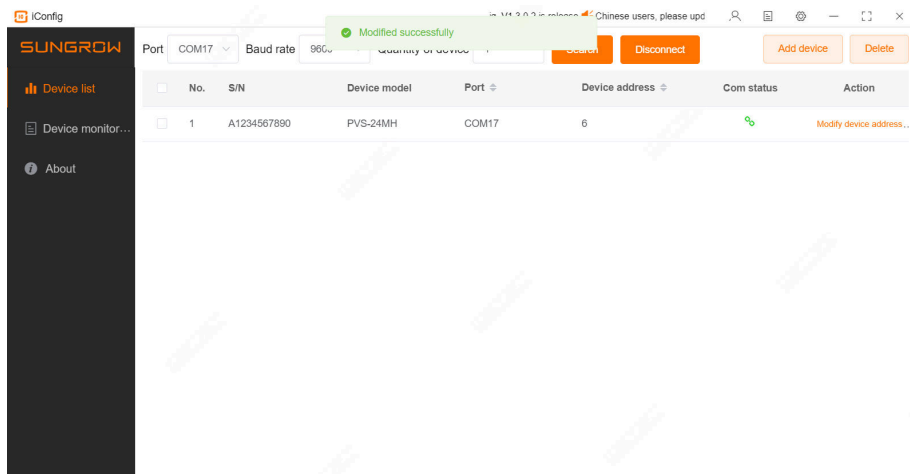
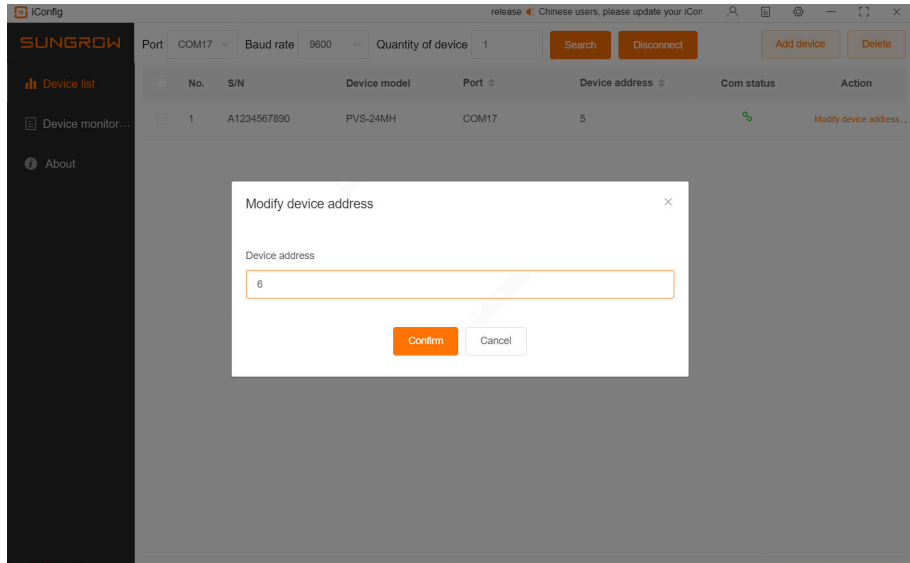

--End

8.3 One-Click Trip

The one-click trip of the PVS can remotely open the breakers or load switches inside the PVS via software control commands. Note that this function requires the PVS to be equipped with a shunt trip mechanism.

8.3.1 WEB One-Click Trip

You can perform a one-click trip for a single PVS, an individual PV sub-array, or all PVS under an inverter unit.

Step-by-Step Instructions

Step 1 One-Click Trip for Single PVS

- a. Log in to the SCU interface. Click **Device Monitoring**, locate the PVS by its SN or device address, and select it to perform the trip.

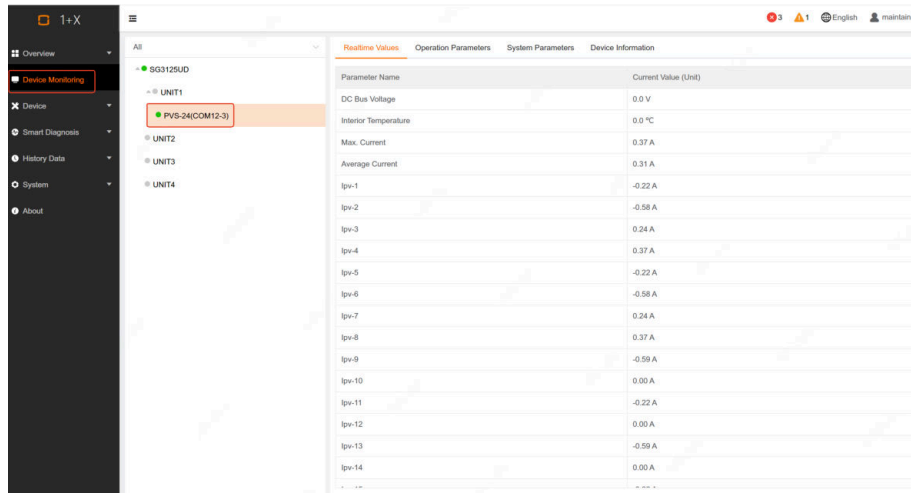

- b. After confirming the PVS, click **System parameters**, select the corresponding parameter, and click **Enable > Settings** to perform the trip.

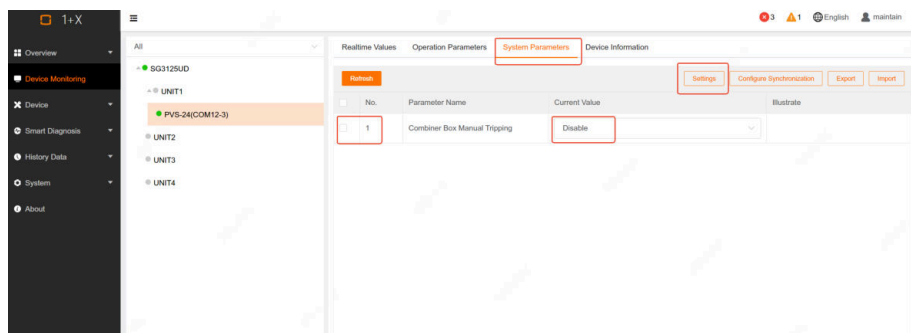

Step 2 One-Click Trip for Sub-Arrays

- a. Log in to the SCU interface. Click **Device Monitoring**, and select the sub-array to be tripped.
- b. After confirming the sub-array, click **System Parameters**, select the corresponding parameter, and click **Enable > Settings** to perform the trip.

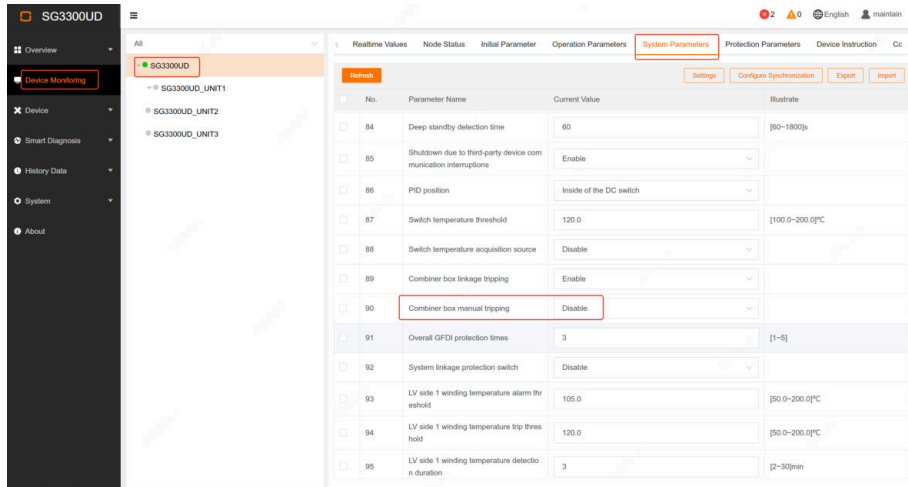

Step 3 One-Click Trip for PVS of Inverter Units

- Log in to the SCU interface. Click **Device Monitoring**, and select the PVS to be tripped.
- After confirming the PVS, click **System Parameters**, select the corresponding parameter, and click **Enable > Settings** to perform the trip.

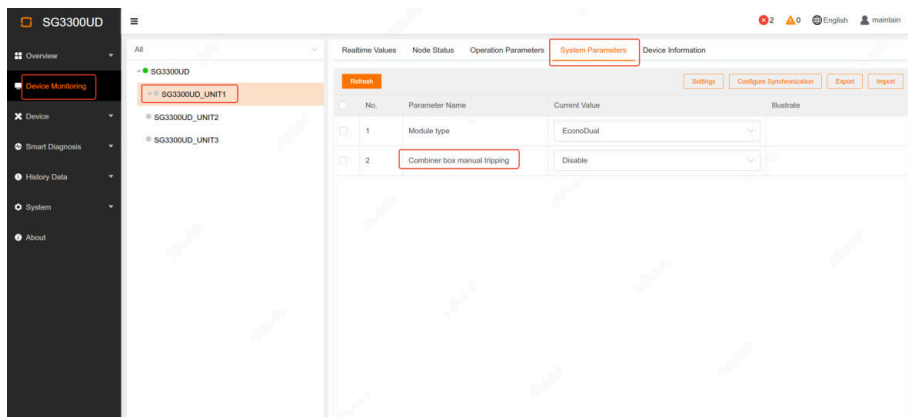

--End

8.3.2 iConfig One-Click Trip

Step-by-Step Instructions

Step 1 Select the PVS to be triggered after the communication between the PVS and PC is established.

Step 2 Select **Tripping**, and click **Settings**.

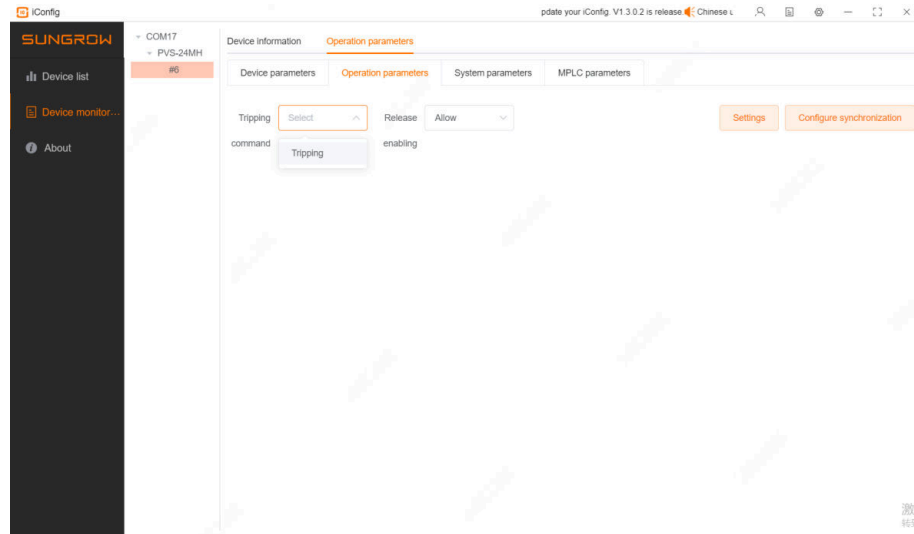

--End

8.3.3 One-Click Trip via Plant Backend

After configuring the relevant settings according to the communication protocol provided by SUNGROW, one-click tripping of the PVS under a PV sub-array or inverter unit can be performed via the plant backend.

8.4 Other Functions

Users can use iConfig to set string access, and monitor PVS status, real-time faults, and operation information.

8.4.1 String Access Settings

Step-by-Step Instructions

Uncheck unused strings according to actual setup, then click **Settings**.

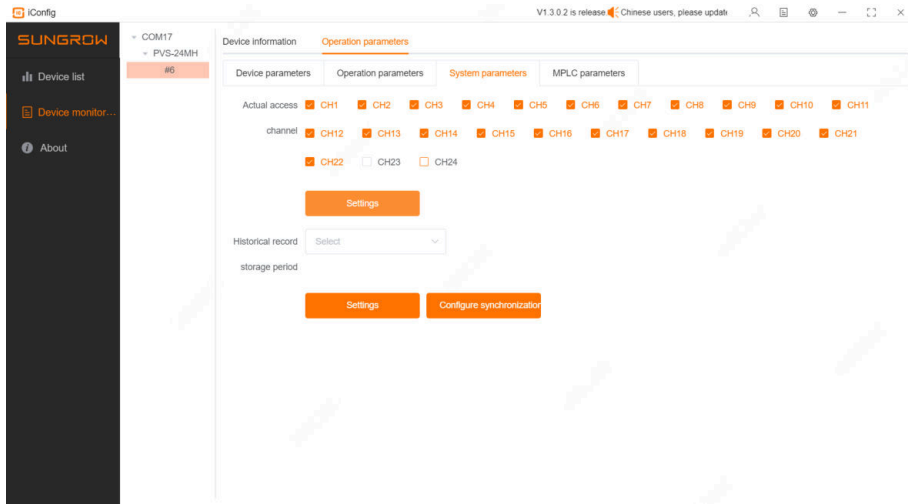

8.4.2 Viewing Real-Time Information

Run Information

Log in to iConfig interface, and click **Device monitoring, Device information > Run information** for viewing.

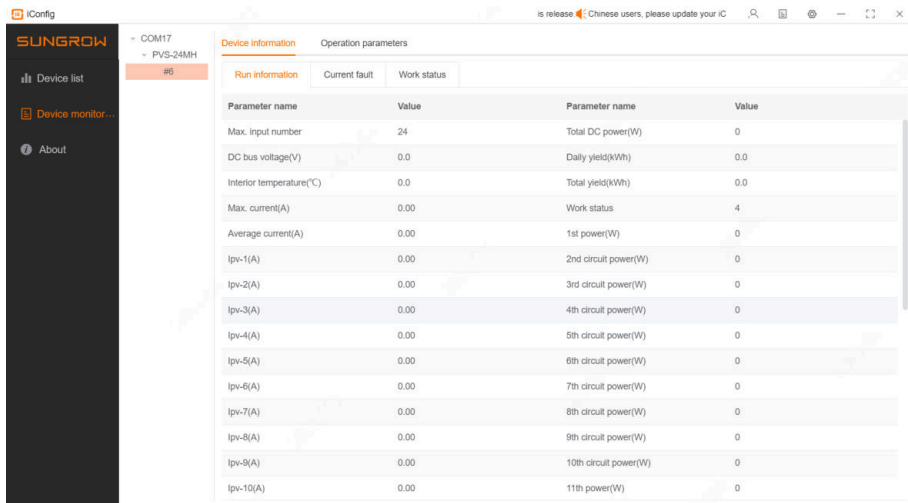

Current fault

Log in to iConfig interface, and click **Device monitoring, Device information > Current fault** for viewing.

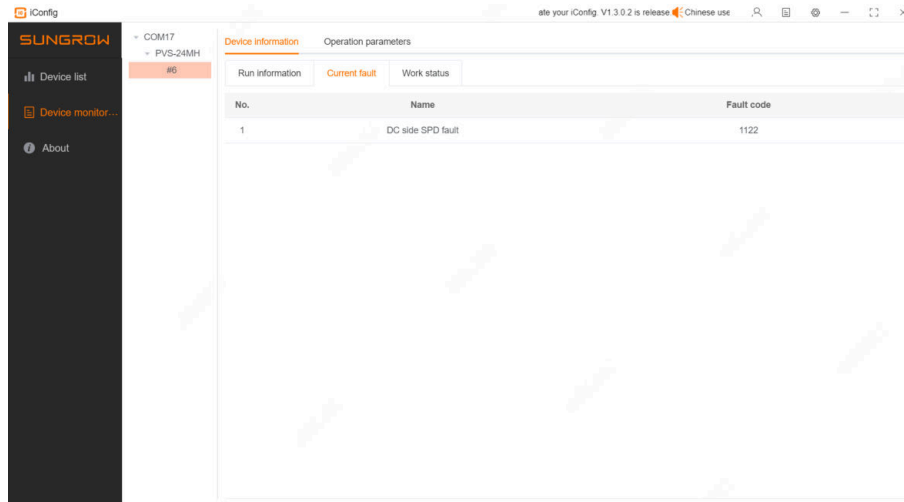

Work Status

Log in to the iConfig interface, and click **Device monitoring, Device information > Work status** for viewing.

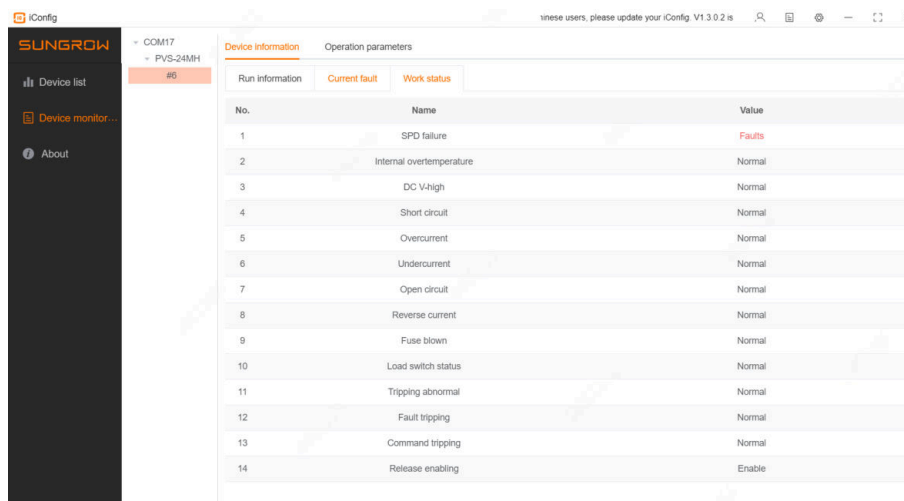

9 Routine Maintenance

9.1 Brief Introduction

Due to the influence of ambient temperature, humidity, dust and vibration, the internal components of the PVS will age and wear, which may lead to potential failures of the PVS. Therefore, it is necessary to implement daily and regular maintenance on the PVS to ensure its normal operation and service life.

WARNING

Only qualified electricians can perform the maintenance work described in this chapter.

NOTICE

Do not leave screws, washers, or other metal parts in the PVS during maintenance. Otherwise, damage may be caused to the device!

Shut down the PVS before maintaining hardware to ensure the parts that may be touched are voltage free.

9.2 Maintenance Work

Inspection content	Inspection method	Maintenance cycle
Electrical connection	Check the fuse holder, PG gland terminal and other joints for looseness and dislodgement. Check the cables for damage.	3 months/time
Sealing strip inspection	Regularly check the sealing strip for bubbles, cracks, broken skin and lack of glue, pits, etc.	1-2 months/time in the first period, usually 1 year/time

The recommended routine maintenance periods in the table are only for reference. The actual maintenance period shall be determined reasonably in consideration of the specific installation environment of the product. Power plant scale, location, site environment, and other factors also affect the maintenance period of the product. It is necessary to shorten the maintenance period and increase the maintenance frequency in the event of a heavy sandstorm or dust in the operating environment.

9.3 Fuse Replacement

Prerequisite

⚠ WARNING

**Once the fuse is blown, it cannot be restored and should be replaced by a qualified operator in time.
Replace the fuse with a new one of the same model and the same grade.**

Follow the procedure below to replace the fault fuse.

- Step 1** Disconnect load switch/circuit breaker.
- Step 2** Use a clamp meter to measure the current of each channel to ensure that the current is 0.
- Step 3** Open the fuse box and remove the fuse.
- Step 4** Install a fuse of the same size.
- Step 5** Close the fuse box.
- Step 6** Connect the load switch/circuit breaker.

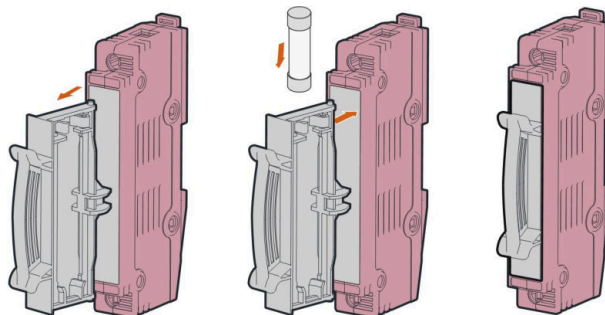

Figure 9-1 Fuse replacement steps

--End

⚠ WARNING

Push the fuse holder back into place and fasten it after the fuse is replaced.

⚠ WARNING

Disconnect the load switch before checking and replacing the fuse. Please notice that high voltage still exists in all terminals of the load switch. Make sure the current of each input is zero by a clamp meter and only then can the fuse be replaced.

9.4 Sealing Strip Replacement

The internal sealing strip wraps around the door, shown as “A” in the figure below. It is recommended to check the sealing strip regularly. If there is any damage caused due to non-human factors, please contact SUNGROW immediately to replace the door and the sealing strip.

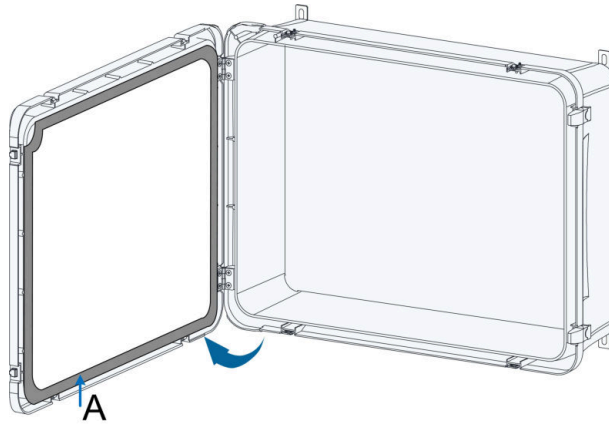

10 Troubleshooting

10.1 Before Troubleshooting

Please notice the following items before troubleshooting:

- Disconnect the load switch before operation.
- Do not touch bare metal parts such as copper bar under the protective plate.
- Pull out the fuse holder to disconnect the input for maintenance of the combiner busbar.

WARNING

High voltage may still exist in terminals of the load switch when it is disconnected! The fuse holder may still be live when the fuse is removed. Please do not touch it.

10.2 Troubleshooting

Table 10-1 Fault List

Fault Name	Fault Cause	Troubleshooting Method
Ambient temperature too high	The temperature inside the device is too high. The ambient operating temperature is too high.	Generally, the device will resume operation after the internal temperature or module temperature returns to normal. If the fault occurs repeatedly: <ol style="list-style-type: none">1. Check whether the ambient temperature is too high.2. Check whether the location of the device is well-ventilated.3. Check whether the device is exposed to direct sunlight; if so, provide shading for it.4. If the fault does not arise for the aforementioned reason and still cannot be resolved, please contact SUNGROW Customer Service.
System fault	The internal module of the system is abnormal. The system wiring or terminals are abnormal.	<ol style="list-style-type: none">1. Check whether the internal wiring of the system is broken or whether the terminals are loose.

Fault Name	Fault Cause	Troubleshooting Method
		<ol style="list-style-type: none"> <li data-bbox="784 245 1244 382">2. If there is no broken wiring or loose connection but the fault still cannot be resolved, please contact SUNGROW Customer Service.
PV abnormal alarm	There is short-circuit, open-circuit, or low current issue in the string.	<p data-bbox="784 411 1244 509">Check whether the device voltage and current are within normal range, and determine the cause:</p> <ol style="list-style-type: none"> <li data-bbox="784 519 1244 656">1. Check whether the corresponding module is sheltered. If so, remove the shelter and ensure the module is clean. <li data-bbox="784 666 1244 803">2. Check whether the PV module cables are loose. If so, reconnect the cables and ensure the connection is secure. <li data-bbox="784 813 1244 872">3. Check whether the fuse is damaged. If so, replace the fuse. <li data-bbox="784 882 1244 1009">4. If the alarm does not arise for the aforementioned reason and still cannot be removed, please contact SUNGROW Customer Service.
PV reverse connection alarm	The PV string is connected with reverse polarity.	<ol style="list-style-type: none"> <li data-bbox="784 1048 1244 1293">1. Check whether the negative and positive cables of the corresponding PV string is connected in reverse. If so, after the PV string current drops below 0.5A, turn off the DC switch, pull out all fuses, and correct the wiring to ensure correct polarity. <li data-bbox="784 1303 1244 1430">2. If the alarm does not arise for the aforementioned reason and still cannot be removed, please contact SUNGROW Customer Service.
AFCI fault	AFCI fault on the DC side.	<ol style="list-style-type: none"> <li data-bbox="784 1460 1244 1705">1. Check the output cables for damage, inspect the terminals for loose connections or poor contact, and look for burn marks on the components. If any issues are found, replace the cables or components and tighten the terminals accordingly. <li data-bbox="784 1715 1244 1773">2. After completing the DC side inspections in Step 1, reconnect DC

Fault Name	Fault Cause	Troubleshooting Method
		power and turn on the DC switch. The device will resume operation.
		3. If the AFCI fault repeats, please contact SUNGROW Customer Service.

11 Appendix

11.1 Technical Data

PVS-16MH /PVS-18MH /PVS-20MH /PVS-24MH

Electric Parameters	PVS-16MH	PVS-18MH	PVS-20MH	PVS-24MH
Max. PV string voltage	1500V			
Max. PV string parallel inputs	16	18	20	24
SPD	1500 Vdc Type II (Optional: Type I+II)			
Input terminal type	Special connector for PV cable			
Output terminal type	120 ~ 400 mm ²			
Degree of protection	IP67			
Ambient temperature*	-40°C ~ +60°C			
Ambient humidity	0~95%			
Dimensions (width * height * depth)	950×730×275 mm			
Weight	≤48 kg			
Switch disconnect handle	Internal handle			
Material	SMC			
Standard Accessories				
DC output load switch	Yes			

Electric Parameters	PVS-16MH	PVS-18MH	PVS-20MH	PVS-24MH
PV specific application SPD			Yes	
DC Arc Detection	Yes (Only used with Sungrow 1 + X inverter)			
IV Diagnosis	Yes (Only used with Sungrow 1 + X inverter)			
String current and bus voltage monitoring			Yes	
RS485 communication port			Yes	
PV SPD failure monitoring			Yes	
Monitoring for load switch state			Yes	
Operator access areas IP2X			Yes	
Special connector for PV cable (JK03M2)			Yes	
One-click trip			Yes	
MPLC Communication	Optional (Only used with Sungrow 1 + X inverter)			

*: The ambient temperature is determined as the average temperature obtained from at least four evenly distributed temperature monitoring points located at a distance of 1 meter from the equipment, at a height halfway up the machine. The temperature sensors must be shielded from airflow, thermal radiation, and rapid temperature fluctuations to prevent display inaccuracies.

PVS-16MH-EH /PVS-18MH-EH /PVS-20MH-EH /PVS-24MH-EH

Electric Parameters	PVS-16MH-EH	PVS-18MH-EH	PVS-20MH-EH	PVS-24MH-EH
Max. PV string voltage			1500V	
Max. PV string parallel inputs	16	18	20	24

Electric Parameters	PVS-16MH-EH	PVS-18MH-EH	PVS-20MH-EH	PVS-24MH-EH
SPD	1500 Vdc Type II (Optional: Type I+II)			
Input terminal type	Special connector for PV cable			
Output terminal type	120 ~ 400 mm ²			
Degree of protection	IP65			
Ambient temperature*	-40°C ~ +60°C			
Ambient humidity	0~95%			
Dimensions (width * height * depth)	950×730×275 mm			
Weight	≤48 kg			
Switch disconnect handle	External handle			
Material	SMC			
Standard Accessories				
DC output load switch	Yes			
PV specific application SPD	Yes			
External handle	Yes			
Operator access areas IP2X	Yes			
Special connector for PV cable (JK03M2)	Yes			
Monitor	Optional (Contain String current and voltage monitoring, RS485 communication port, PV SPD failure monitoring, DC Arc Detection and Monitoring for load switch state)			

*: The ambient temperature is determined as the average temperature obtained from at least four evenly distributed temperature monitoring points located at a distance of 1 meter from the equipment, at a height halfway up the machine. The temperature sensors must be shielded from airflow, thermal radiation, and rapid temperature fluctuations to prevent display inaccuracies.

11.2 Quality Assurance

When product faults occur during the warranty period, SUNGROW will provide free service or replace the product with a new one.

Evidence

During the warranty period, the customer shall provide the product purchase invoice and date. In addition, the trademark on the product shall be undamaged and legible. Otherwise, SUNGROW has the right to refuse to honor the quality guarantee.

Conditions

- After replacement, unqualified products shall be processed by SUNGROW.
- The customer shall give SUNGROW a reasonable period to repair the faulty device.

Exclusion of Liability

In the following circumstances, SUNGROW has the right to refuse to honor the quality guarantee:

- The free warranty period for the whole machine/components has expired.
- The device is damaged during transport.
- The device is incorrectly installed, refitted, or used.
- The device operates in harsh conditions beyond those described in this manual.
- The fault or damage is caused by installation, repairs, modification, or disassembly performed by a service provider or personnel not from SUNGROW.
- The fault or damage is caused by the use of non-standard or non-SUNGROW components or software.
- The installation and use range are beyond stipulations of relevant international standards.
- The damage is caused by unexpected natural factors.

For faulty products in any of above cases, if the customer requests maintenance, paid maintenance service may be provided based on the judgment of SUNGROW.

Product data such as product dimensions are subject to change without prior notice. The latest documentation from SUNGROW should take precedence in case of any deviation.

11.3 Contact Information

In case of questions about this product, please contact us. We need the following information to provide you the best assistance:

- Model of the device
- Serial number of the device
- Fault code/name
- Brief description of the problem

For detailed contact information, please visit: <https://en.SUNGROWpower.com/contactUS>

